



3651 N Highway 89 • Chino Valley, AZ 86323
(928) 636-7080 • www.p-a-g.net

DODGE RAM 1500 2 & 4WD GASOLINE ENGINES 3" BODY LIFT, INCLUDING AIR-RIDE 2009-2014 KIT# 60203

⚠ WARNING

Installation of a Performance Automotive Group body lift kit will change the vehicle's center of gravity and handling characteristics both on- and off-road. You must drive the vehicle safely! Extreme care must be taken to prevent vehicle rollover or loss of control, which could result in serious injury or death. Avoid sudden sharp turns or abrupt maneuvers and always make sure all vehicle occupants have their seat belts fastened.

⚠ WARNING

Before you install this kit, read and understand all instructions, warnings, cautions, and notes in this instruction sheet and in the vehicle owner's manual.

⚠ CAUTION

Proper installation of this kit requires knowledge of the factory recommended procedures for removal and installation of original equipment components. We recommend that the factory shop manual and any special tools needed to service your vehicle be on hand during the installation. Installation of this kit without proper knowledge of the factory recommended procedures may affect the performance of these components and the safety of the vehicle. We strongly recommend that a certified mechanic familiar with the installation of similar components install this kit.

⚠ WARNING

DO NOT combine suspension, body, or other lift devices. Use of vehicle with combined lifts may result in unsafe and/or unexpected handling characteristics.

NOTE

Front bumper tow hooks can NOT be used following the installation of this kit.

⚠ WARNING

This kit should only be installed on a vehicle that is in good working condition. Before you install the kit, thoroughly inspect the vehicle for corrosion or deformation of the sheet metal around the factory body mounts. If the vehicle is suspected to have been in a collision or misused, do not install this kit. Off-road use of your vehicle with this kit installed may increase the stress applied to the factory body mounts. We do not recommend that any vehicle with a body lift kit installed be involved in any extreme off-road maneuvers such as jumping. Failure to observe this warning may result in serious personal injury and/or severe damage to your vehicle.

⚠ WARNING

Many states and municipalities have laws restricting bumper heights and vehicle lifts. Consult state and local laws to determine if the changes you intend to make to the vehicle comply with the law.

⚠ WARNING

The installation of larger tires may reduce the effectiveness of the braking system.

⚠ WARNING

Always wear eye protection when operating power tools.

⚠ WARNING

Before you install this kit, block the vehicle tires to prevent the vehicle from rolling.

⚠ WARNING

Accidental deployment of the air bag can result in serious personal injury or death. To avoid accidental deployment during installation of the kit, the Supplemental Restraint System (SRS, or airbag) must remain deactivated. Do not allow anyone near the airbag during installation. Refer to the factory service manual or owner's manual for the recommended procedure to disable the SRS. After you install the kit, reactivate the SRS before driving the vehicle.

NOTE

Performance Automotive Group recommends using the Loctite® supplied in the kit on the threads of all kit nuts and bolts unless specified otherwise in these instructions.

Before Starting Installation

NOTE

Kit parts are prefaced by the word **kit** and appear in **bold** print.

1. Carefully read all warnings and instructions completely before beginning.
2. Verify all parts have been received in this kit by checking the parts list at the end of this document.

NOTE

If parts are missing from kit, please be prepared to provide the following information:

1. **Name** of purchase location
 2. **Bar Code** on side of box
 3. **Date** above bar code
 4. **Date** inside box cover
 5. **Inspector #** from inside box cover
3. **Only install this kit on the vehicle for which it is specified.** If anytime during the installation you encounter something different from what is outlined in the instructions, call technical support at (928) 636-7080.
 4. Special tools needed:
 - a. Welder or access to a professional welding shop.
 - b. Drill with 1/2" drill bit.
 - c. Die grinder, cut off wheel, sawzall, or similar tool capable of cutting metal.
 5. Park vehicle on a clean, dry, flat, level surface and block tires so vehicle cannot roll in either direction.

Engine Compartment

1. Disconnect both battery cables. Disconnect negative cable first, then positive cable.

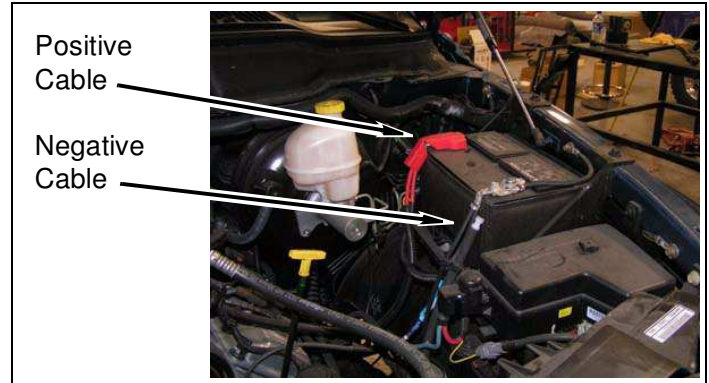

2. Airbag Fuse

NOTE

The location of the airbag fuse may vary; check the vehicle owner's manual.

- a. Remove fuse cover.
- b. Remove airbag fuse.

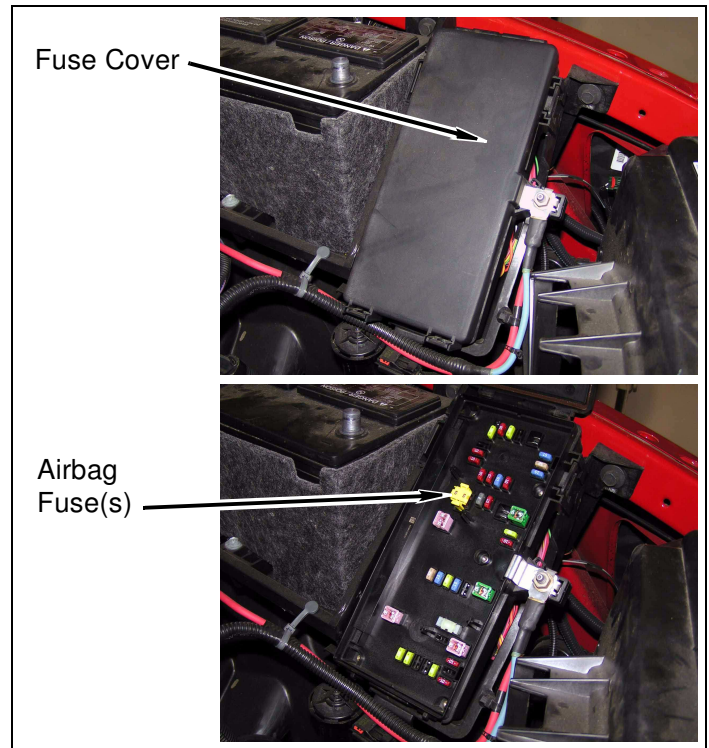

Prepare to Install Kit

Measurements

1. Measure and record distance between front bumper and fenders.

Driver Side _____ Passenger Side _____

2. Measure and record distance between rear bumper and bed

Driver Side _____ Passenger Side _____

3. Measure and record distance between cab and bed.

Driver Side _____ Passenger Side _____

- c. Remove bumper trim by removing one bolt at each corner(Under inner fender cover). Slide cover forward to remove.

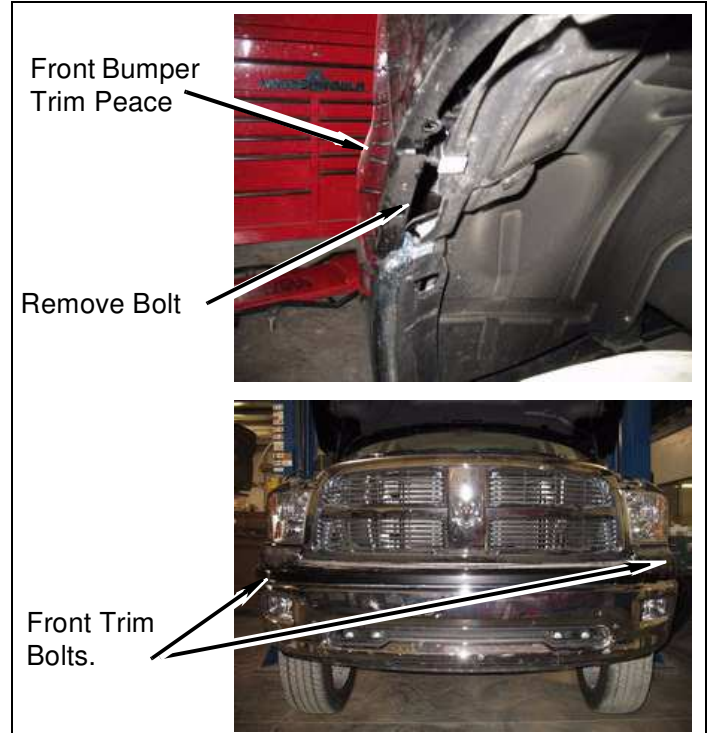

Front of Vehicle

1. Front bumper
 - a. Remove front grill by removing four bolts from top, then pulling grill out.
 - b. Remove push clips and lower splash guard from bumper, core support, and fan shroud.

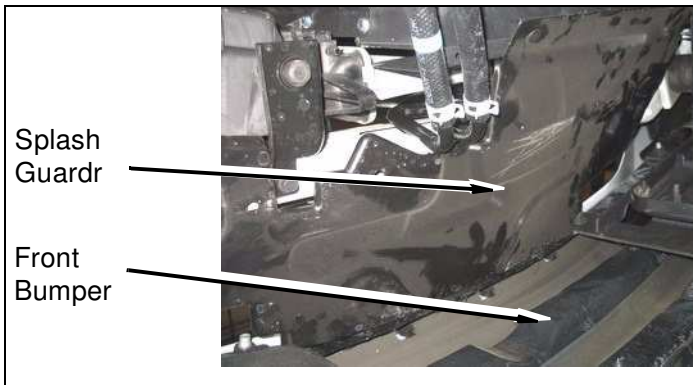

- d. Remove grill support by removing two bolts from each side.
- e. Disconnect fog light harness at driver side of front bumper and pull connector off of front bumper, if equipped.

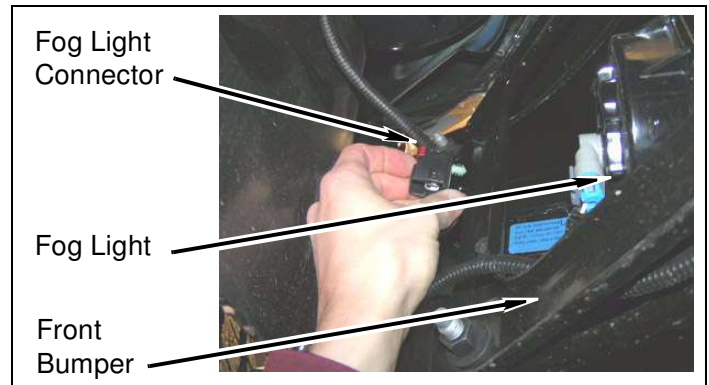

- f. Remove three bolts for drivers side factory tow hook and remove tow hook. Repeat to passenger side

- g. Remove six nuts and front bumper from frame horns .

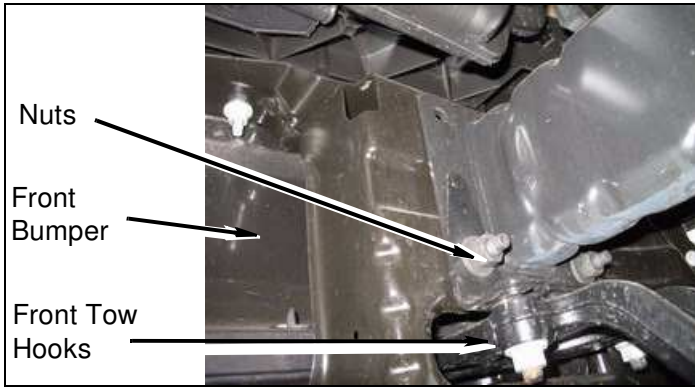

- c. Remove lower fan shroud section(Will not be reused).

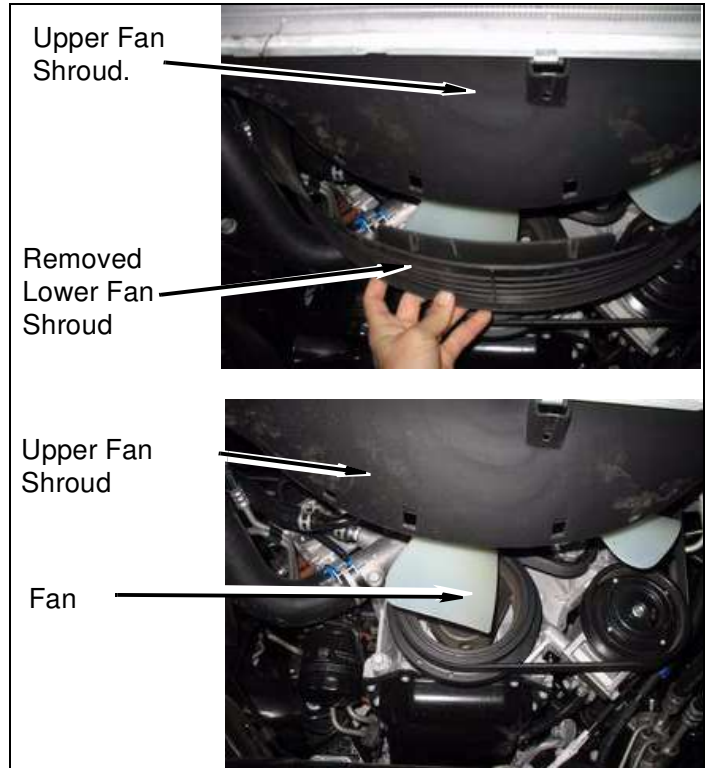

Engine Compartment

1. Airbox

- a. Release four clips from airbox cover. Remove breather hose from airbox cover. Loosen clamp and airbox hose at intake housing.

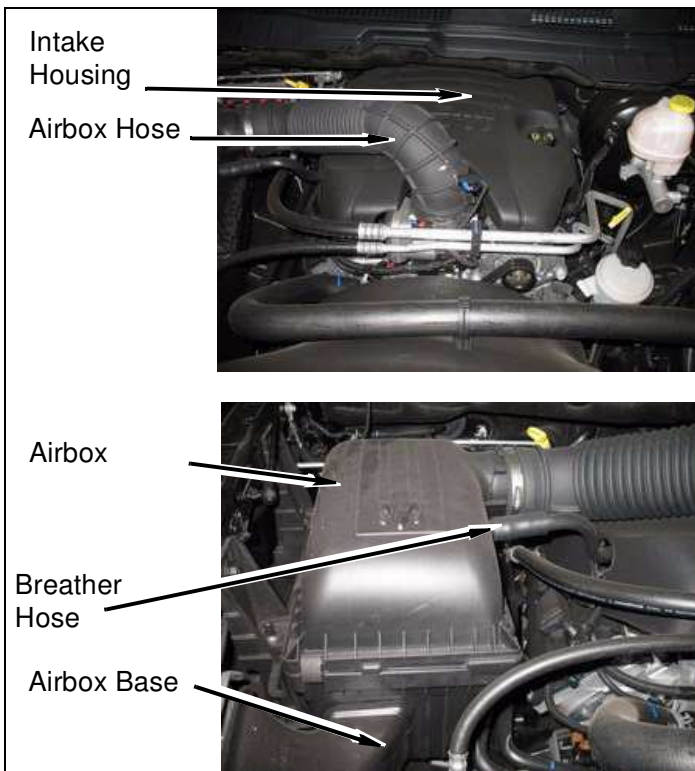

- b. Remove airbox cover, base and filter from vehicle.

2. Steering Shaft

⚠ WARNING

Accidental deployment of the air bag can result in serious personal injury or death. To avoid accidental deployment during installation of the lift kit, the Supplemental Restraint System (SRS, or airbag) must remain deactivated. Do not allow anyone near the airbag during installation. Refer to the factory service manual or owner's manual for the recommended procedure to disable the SRS. After kit installation, the SRS must be reactivated before driving the vehicle.

⚠ CAUTION

If the following step is not performed, the airbag clockspring could be damaged. Do not turn the steering wheel while the steering shaft is disconnected.

- a. Strap steering wheel to prevent accidental movement.

- b. Mark intermediate shaft in relation to rack and pinion as shown.

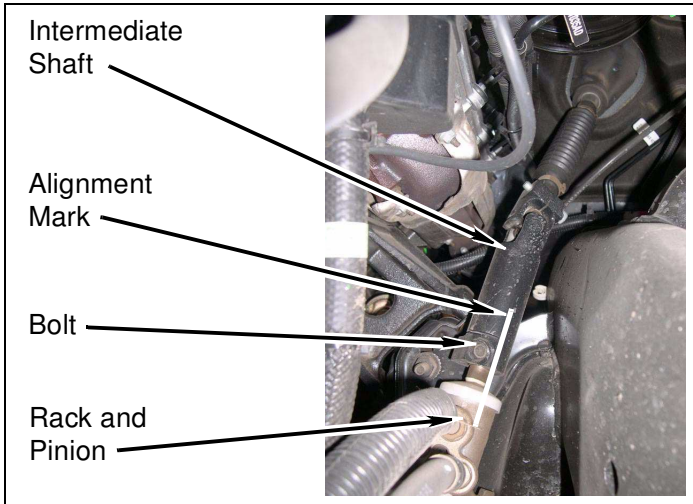

- c. Remove bolt and intermediate shaft from rack and pinion. Slide intermediate shaft up to separate from rack and pinion.

NOTE
Intermediate shaft may not separate from rack and pinion until cab is lifted.

- 3. Remove brake sensor harness from passenger and driver fender wells.

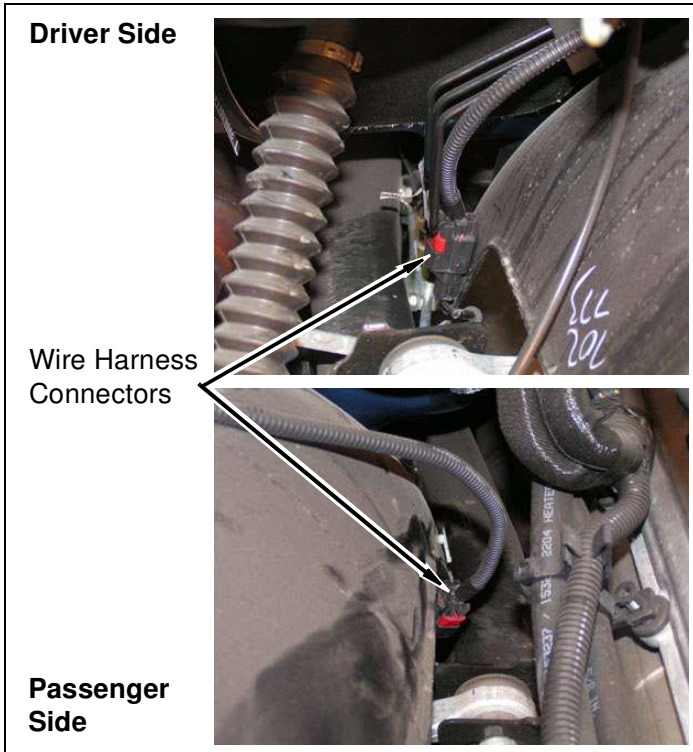

Underside of Vehicle

- 1. Wire harnesses and brake lines

- a. Remove bolts and brake line brackets from driver side frame rail.

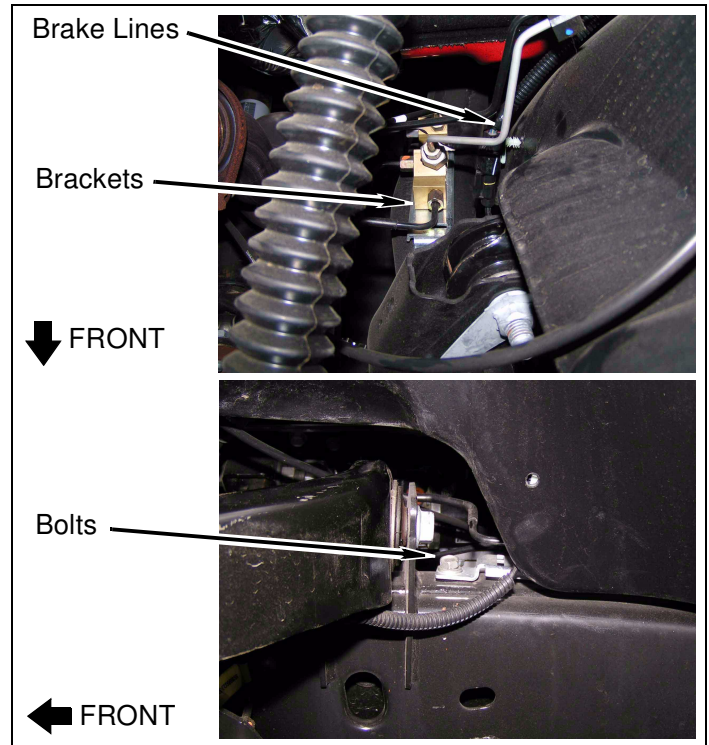

- b. Remove bolt and ground strap from driver side frame rail.

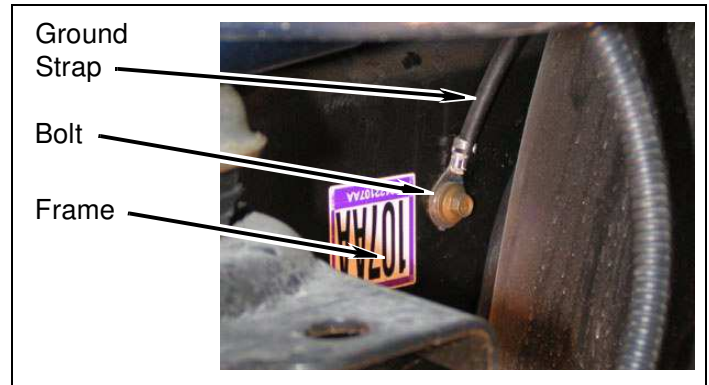

- c. Remove harness from driver side body mount bracket.

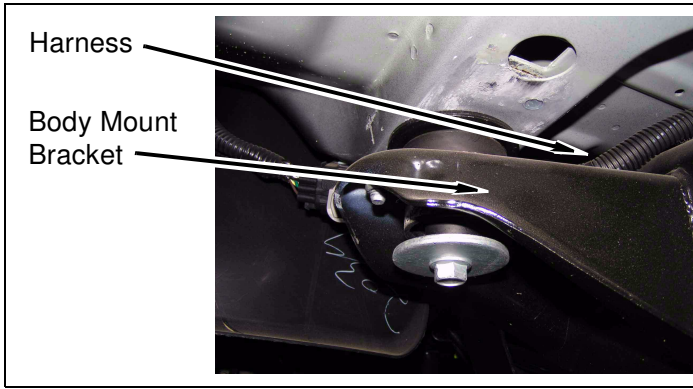

- b. Use expanding pliers to disconnect parking brake cable from junction.

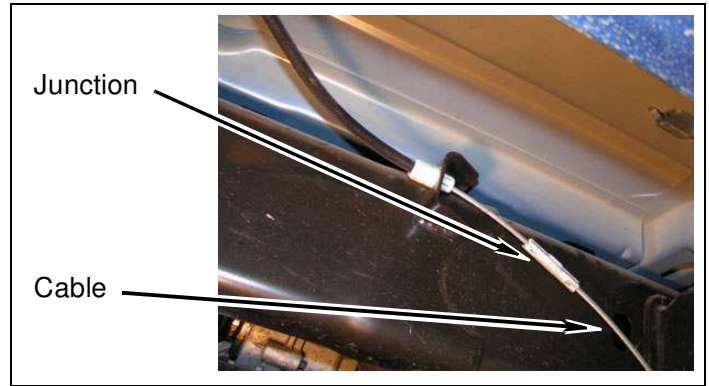

- c. Remove parking brake cable from driver side frame mount.

NOTE
The following procedures applies ONLY to automatic transmissions.

- d. **Automatic transmission models:** Remove transmission shifter cable from clip on driver side brake line.

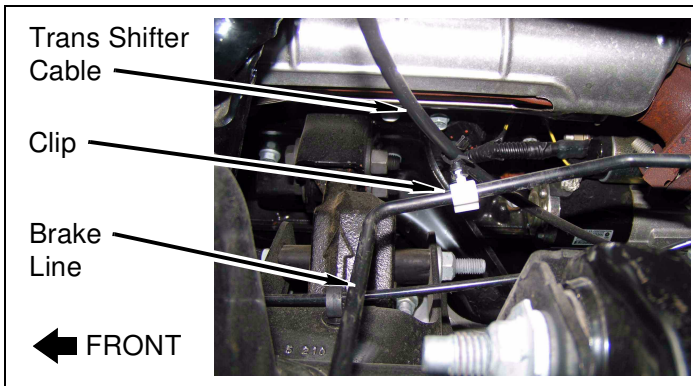

Inside of Vehicle

1. Manual transmission shift lever
 - a. Shift transmission into neutral.
 - b. Unscrew transmission shift lever from shift tower.

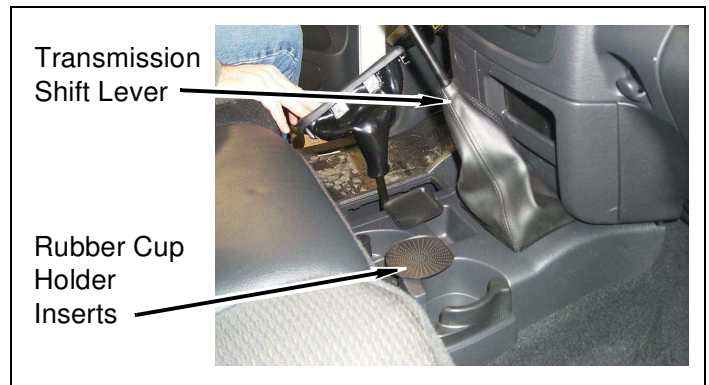

- e. **Automatic transmission models:** Remove transmission wire harness from frame mount clip.

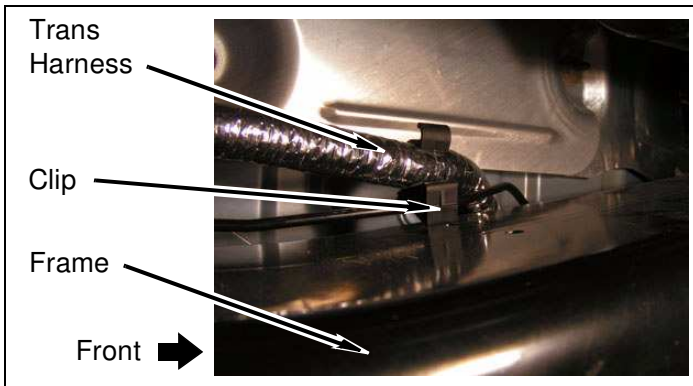

NOTE
Some of the bolts securing the center console to the floor are underneath the cup holder rubber inserts.

- c. Remove bolts and center console from floor.

2. Parking brake cable

- a. Pull slack into parking brake cable. Attach locking pliers to parking brake cable to allow slack, if necessary.

d. Remove six bolts and shift lever boot seal from floor.

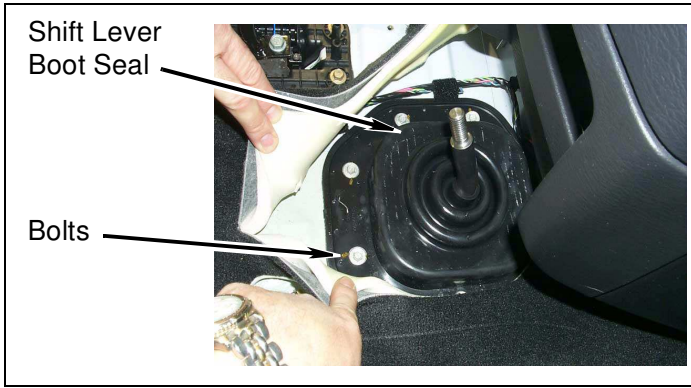

e. Remove rubber cover from shift tower.

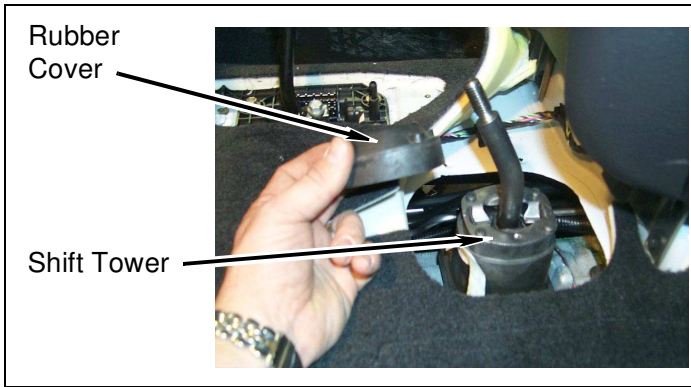

f. Remove four Torx bolts from shift tower mounting plate.

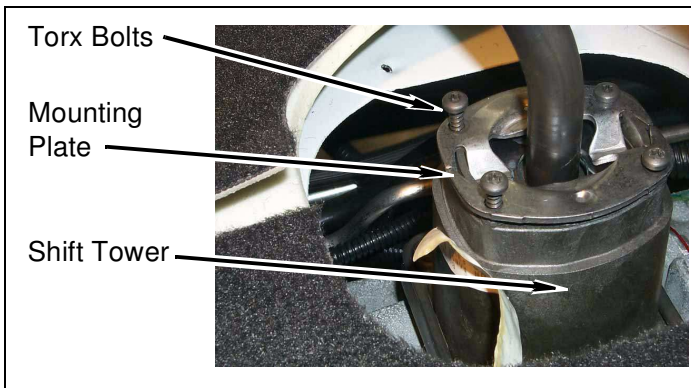

g. Remove shift lever from shift tower.

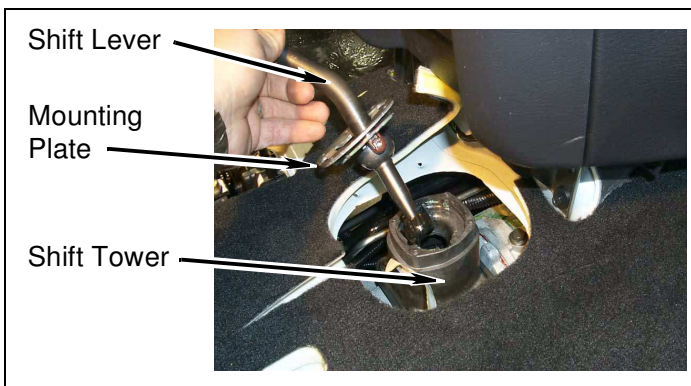

h. Remove two plastic shift tabs, plastic ball, shim and mounting plate from shift lever.

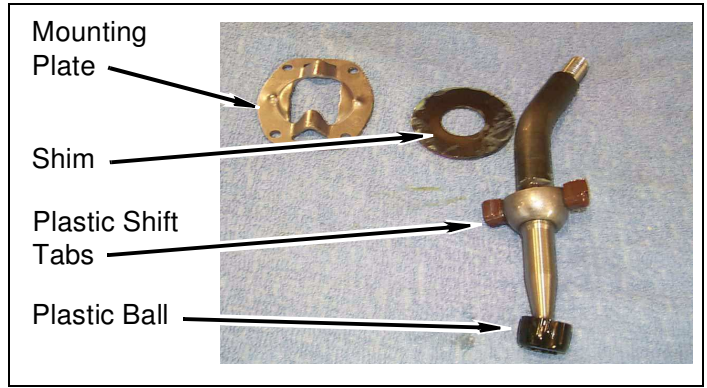

NOTE

The following procedures apply only to vehicles with manual transfer cases.

Rear of Vehicle

1. Fuel filler

⚠ WARNING

Use extreme caution when working near fuel line(s) and fuel tank(s). Clean up spilled fuel immediately. Any spark could cause an explosion or fire resulting in serious personal injury and/or property damage.

a. Remove fuel cap from fuel filler.

2. Ground strap

a. Remove bolt and ground strap from frame near fuel filler hoses.

3. Rear bumper

a. Remove wire harness connectors from rear bumper.

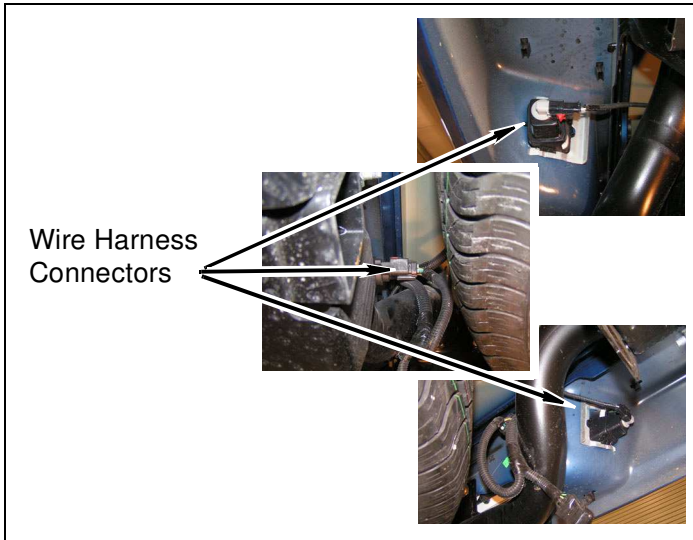

b. Remove two screws and license plate.

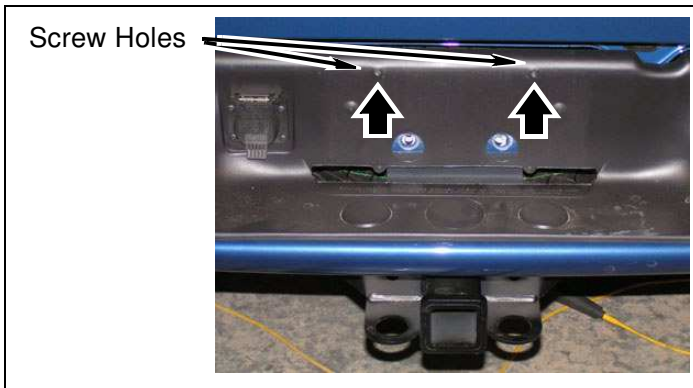

c. Remove four bolts from rear bumper bracket..

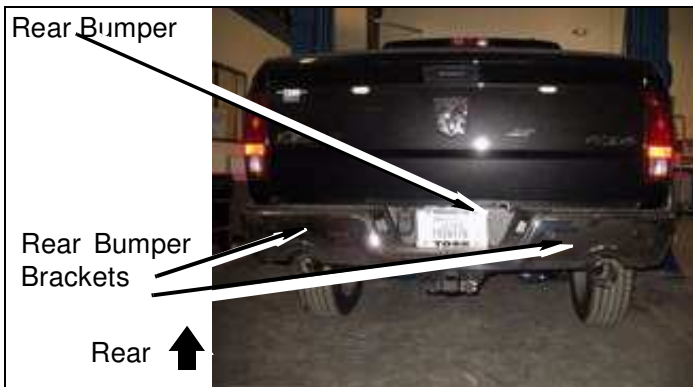

d. Remove two nuts on each side of bumper.

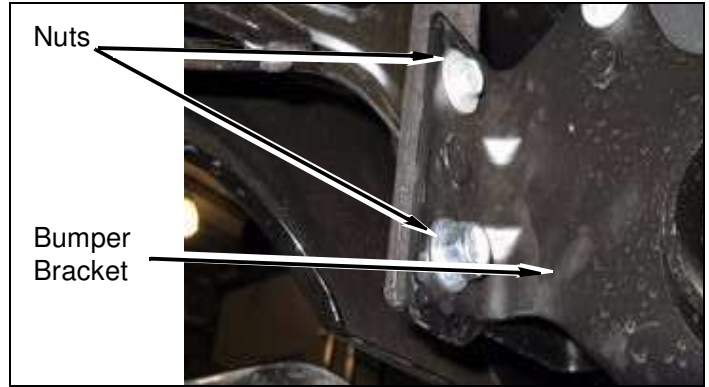

e. Remove two bolts from rear bumper and trailer hitch, if equipped.

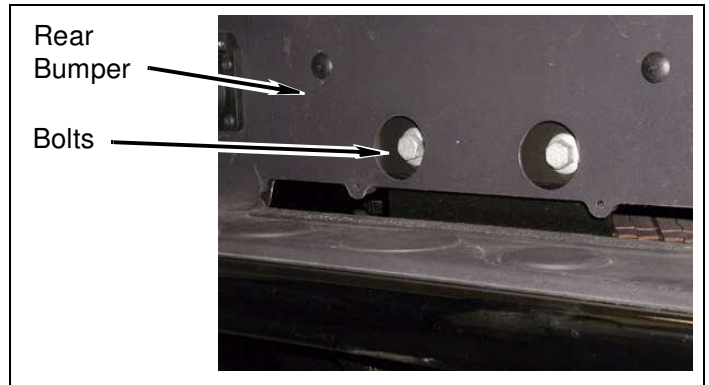

f. Remove rear bumper.

4. Spare tire winch

a. Lower spare tire to ground and remove (see owner's manual for procedure).

b. Remove retaining clip and ratchet tube from spare tire winch.

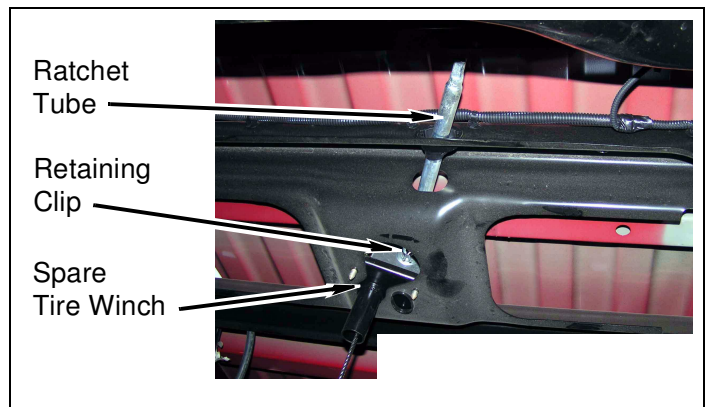

c. Remove Spare tire winch.

- d. Remove plastic ratchet tube guide from cross-member.

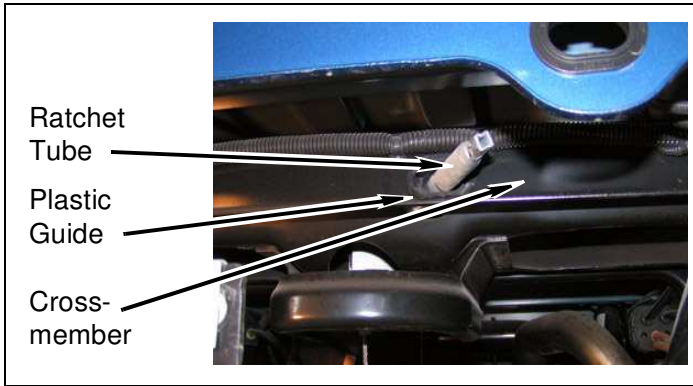

- b. Remove bolt from each cab mount on passenger side.

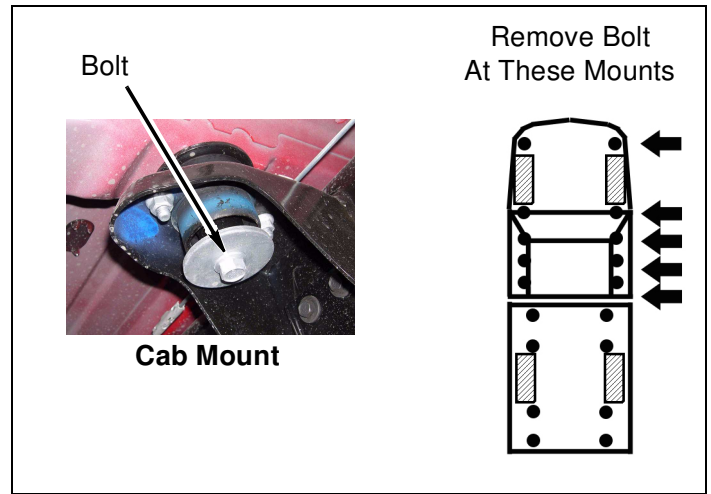

Install Kit

Cab

1. Prepare to lift cab from frame
 - a. Loosen, but DO NOT REMOVE, cab mounting bolts on driver side.

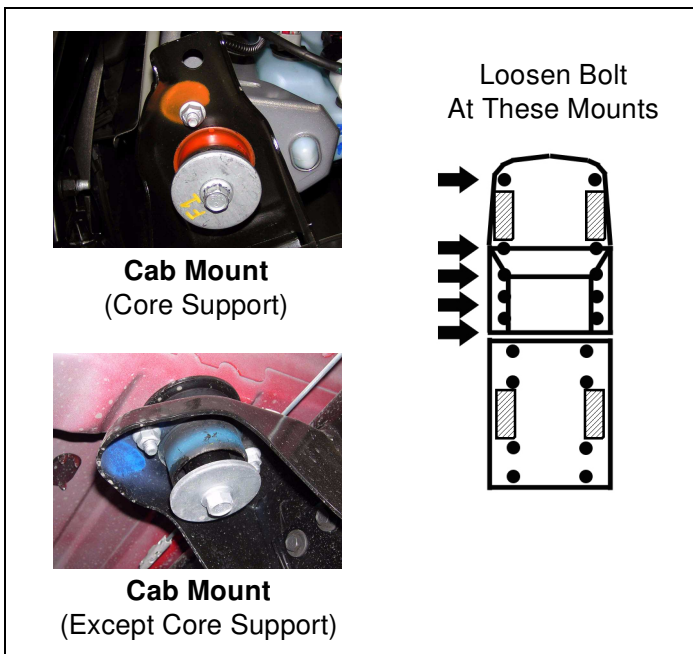

⚠ WARNING
Use extreme caution when lifting body from frame. To prevent serious personal injury, ensure the lifting device is securely placed. Keep your hands out from between the body and frame.

⚠ CAUTION
Continually check hoses, wires, lines, etc. to be sure that everything is flexing properly and not binding, or damage to the vehicle could result. Be especially careful of the a/c hoses at the fire wall, the belt pulley, and at the core support. Ensure brake lines stretch while lifting. Bending the lines to gain ample slack may be necessary. Be extremely careful not to kink the lines.

2. Cab passenger side
 - a. Remove captive washers from each factory cab body mount bolt.

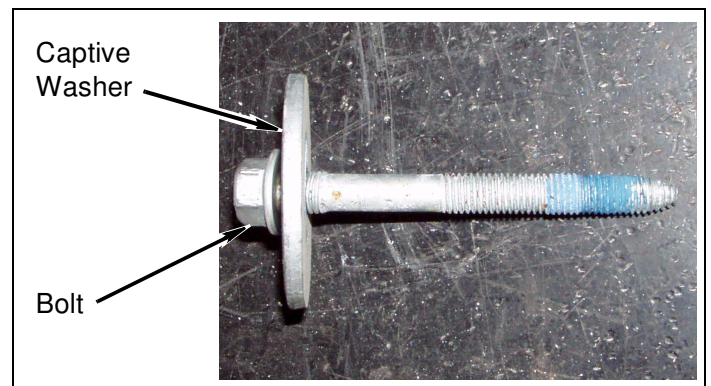

NOTE
The number of cab mounting bolts may vary with the length of the cab.

- b. Position a hydraulic jack and a wood block under passenger side of cab (under the body seam). Slowly lift cab just enough to install a *kit block* on top of factory upper bushing.

⚠ WARNING

The **kit blocks** must be installed in addition to the factory upper and lower bushings. Installing the **kit blocks** without the factory upper and lower bushings could result in damage to the vehicle or serious personal injury.

- c. Place **kit blocks** (3" x 3") on metal cups and upper bushings on each cab mount.

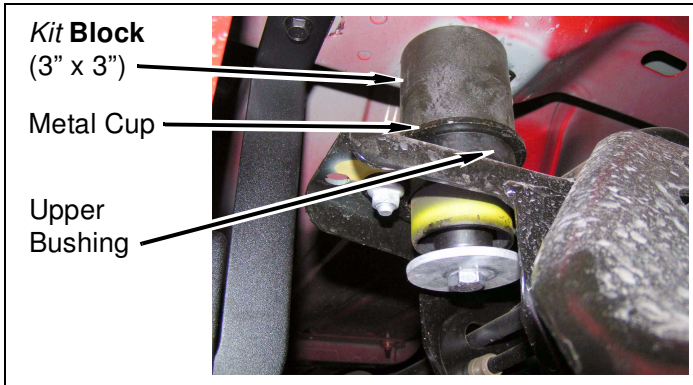

- d. Lower cab onto **kit blocks** (3" x 3").
- e. Install **kit bolt** (12mm-1.75 x 180mm) into each cab mount. **DO NOT TIGHTEN.**

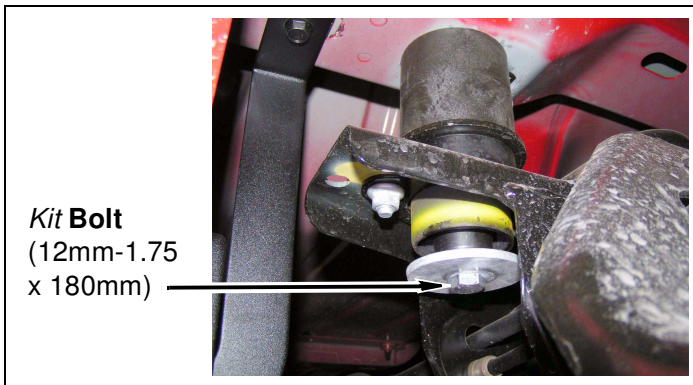

- 3. Cab driver side
 - a. Repeat previous steps on driver side of cab.
 - b. Set cab-to-bed spacing according to previous measurement.

- c. Remove each **kit bolt**, one at a time, and apply a few drops of **kit Loctite®** to threads. Install **kit bolt**, and captive washer. Tighten **kit bolts** to 55 ft. lbs.

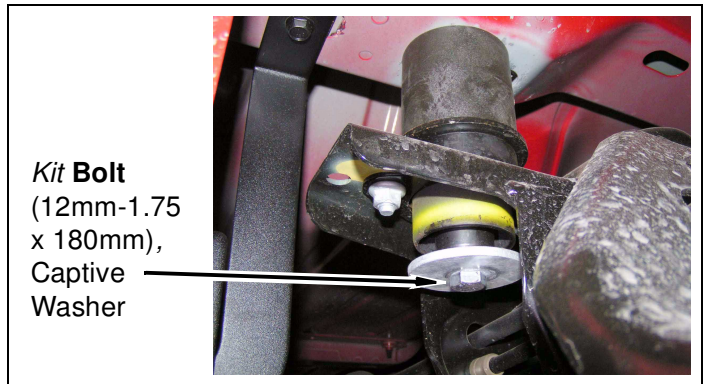

Bed

- 1. Prepare to lift bed from frame
 - a. Loosen, but **DO NOT REMOVE**, bed mounting bolts on driver side.

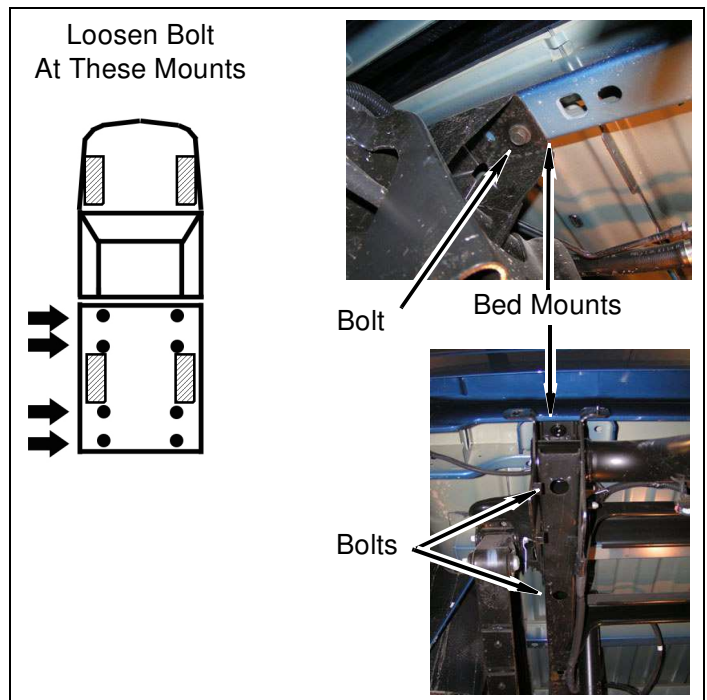

NOTE

The number of bed mounting bolts may vary with the length of the bed.

2. Remove bolt from each bed mount on passenger side.

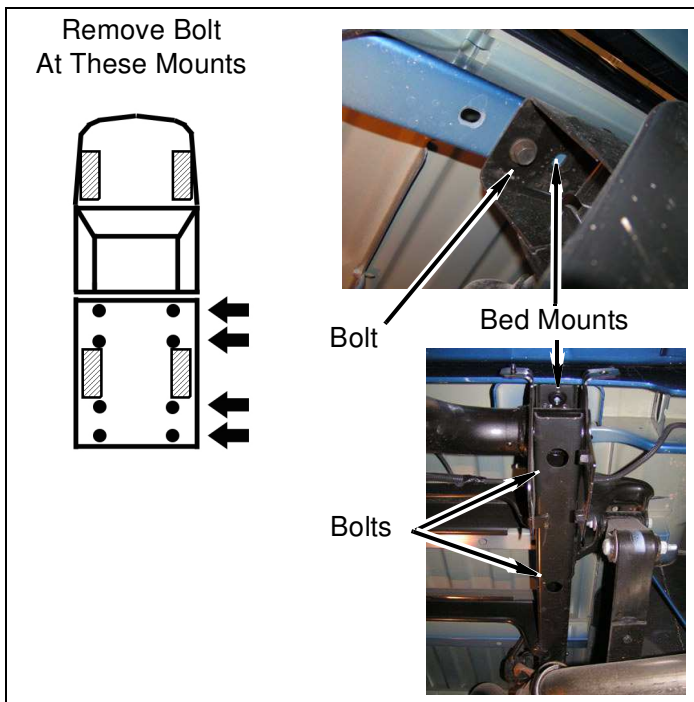

- b. Place a **kit block** (3" x 3") rear frame mount.

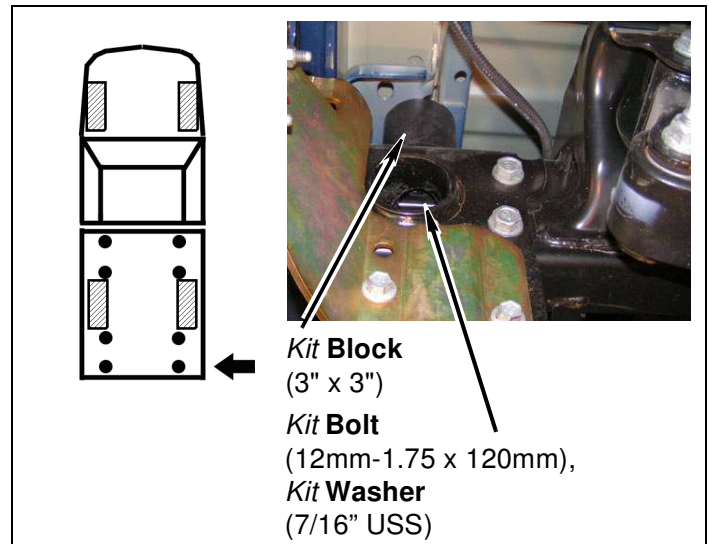

- c. Place **kit blocks** (3" x 3") on two (or three) other frame mounts.

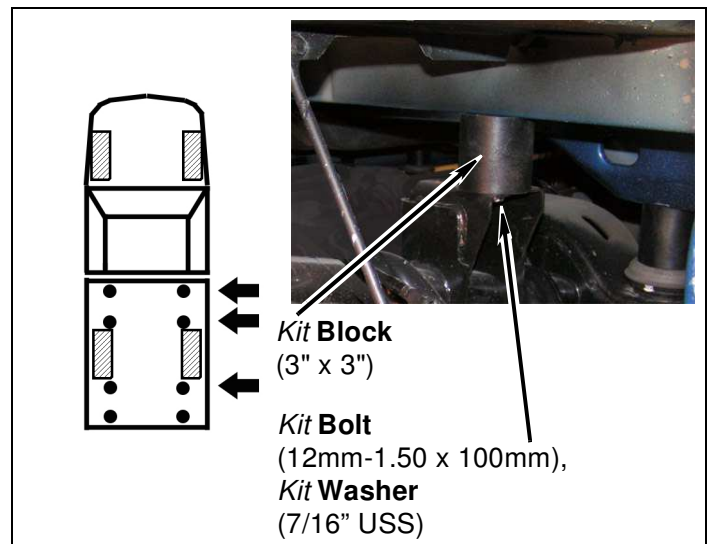

- d. Lower bed onto **kit blocks**.

- e. At rear bed mount, install **kit bolt** (12mm-1.75 x 120mm) and **kit washer** (7/16" USS). DO NOT TIGHTEN.

- f. At each other bed mount, install **kit bolt** (12mm-1.50 x 100mm) and **kit washer** (7/16" USS). DO NOT TIGHTEN.

- g. Repeat previous steps on driver side of bed.

- h. Set bed-to-cab spacing according to previous measurement.

⚠ WARNING

Use extreme caution when lifting the bed from the frame. To prevent serious personal injury, ensure the lifting device is securely placed. Keep your hands out from between the bed and frame.

⚠ CAUTION

To prevent damage to the vehicle while lifting the bed, continually check hoses, wires, brake lines, etc. to ensure everything is flexing properly and not binding. Ensure clearance between bed and cab is maintained.

3. Bed passenger side

- a. Using a hydraulic jack and a wood block, slowly lift passenger side of bed a little more than 3".

- i. Remove each *kit bolt*, one at a time, and apply a few drops of *kit Loctite®* to threads. Install *kit bolt* with *kit washer* (7/16" USS). Tighten *kit bolts* to 55 ft. lbs.

- c. Install spare tire winch onto *kit bracket* (winch) with two *kit bolts* (3/8" x 1"), four *kit washers* (3/8" USS), and two *kit nuts* (3/8" Nylock).

Rear of Vehicle

1. Spare tire winch

- a. Remove two bolts and spare tire winch from crossmember.

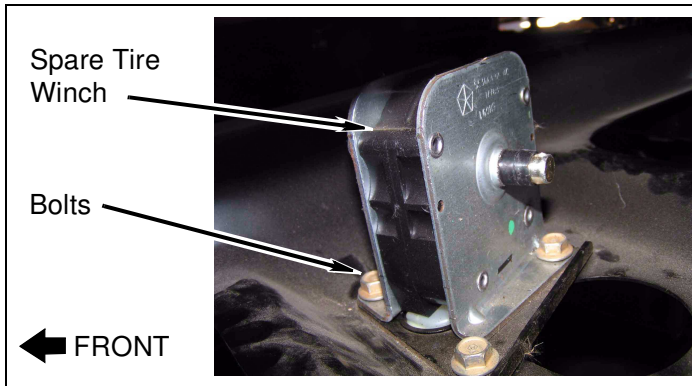

- b. Install *kit bracket* (winch) and mounting plate onto crossmember with two bolts. Position bracket between winch and the frame.

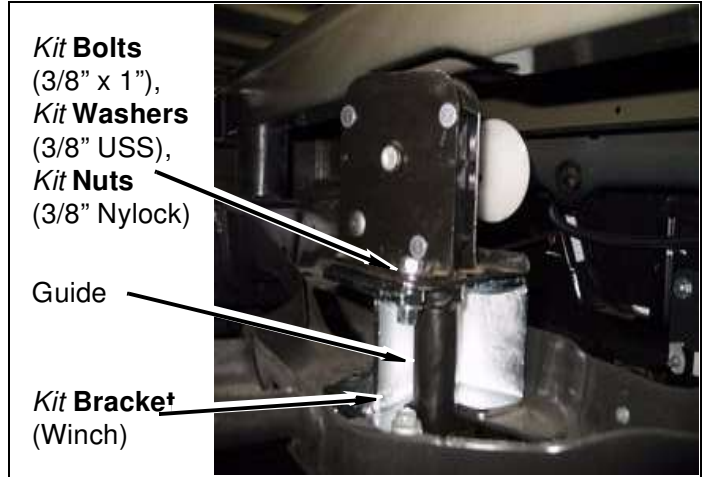
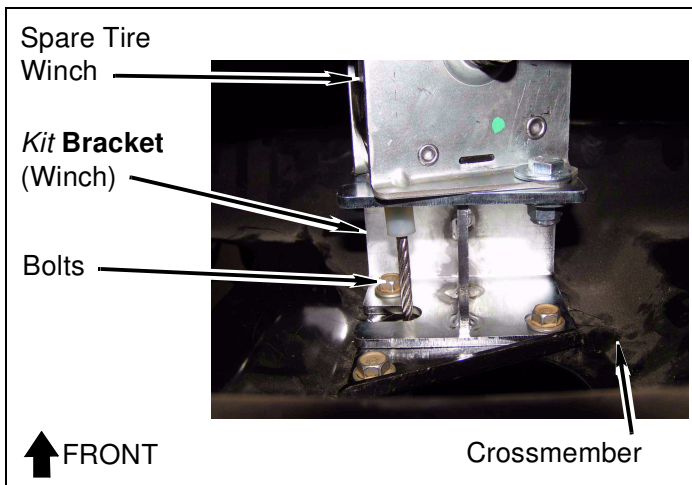

- d. Install ratchet tube onto spare tire winch with retaining clip
- e. Verify ratchet tube is visible through hole in bed and plastic ratchet tube guide. Adjust *kit bracket* (spare tire ratchet tube), if necessary.

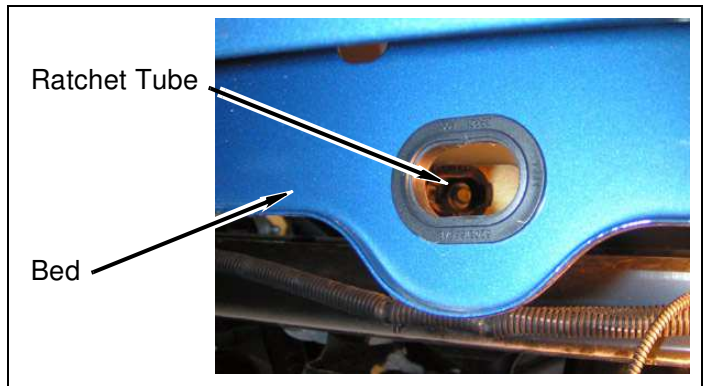

- f. Install spare tire on vehicle (see owner's manual).

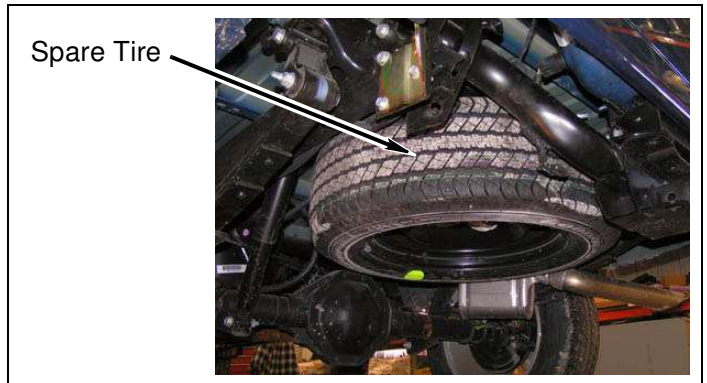

g. Reattach ground strap to frame with bolt near fuel filler hoses.

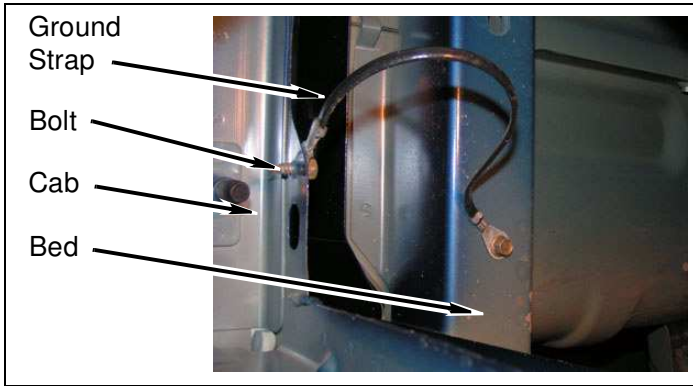

b. Remove stud on each rear bumper bracket..

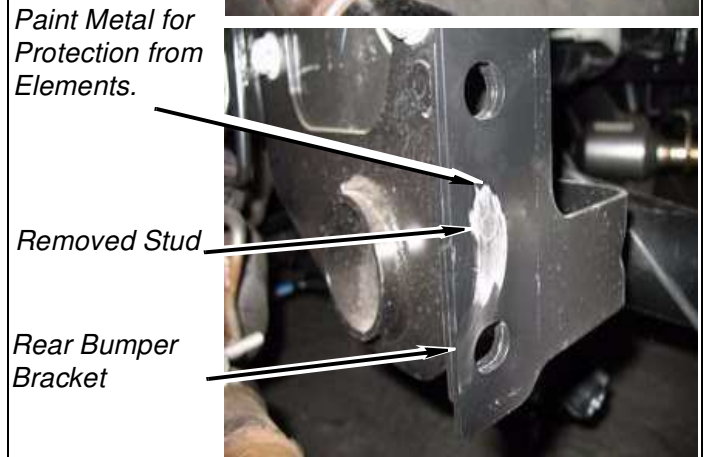
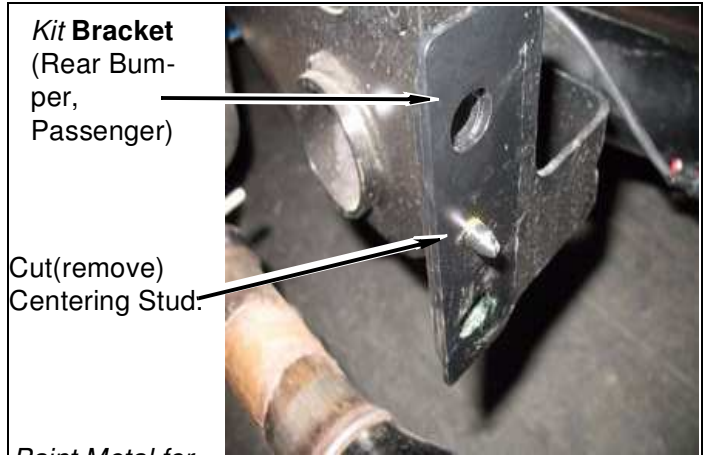

2. Rear bumper

⚠ WARNING
 The following procedure is intended only to enhance the appearance of the vehicle. The rear bumper will no longer be rated for towing of any kind. Towing with the rear bumper after it has been lifted can result in death, serious personal injury, or damage to the vehicle. Towing after the bumper has been lifted should be accomplished using a rated Class III receiver type hitch.

a. Apply a few drops of *kit Loctite*® to factory bolts. Install *kit bracket* (rear bumper, middle) on trailer hitch with two factory bolts. DO NOT TIGHTEN.

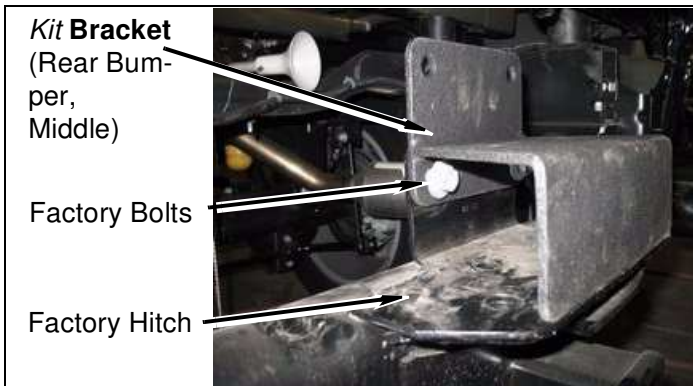

c. Place rear bumper brackets in place with 1/2" bolt. Center bracket so that all holes align..

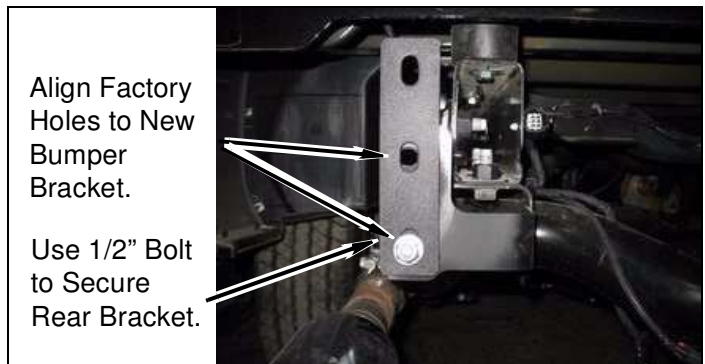

- d. Install rear bumper onto **kit bracket**. DO NOT TIGHTEN. Mark rear bumper and clearance bumper for center bumper support bracket (Cut about 9 1/2" across & 1 3/4" in).

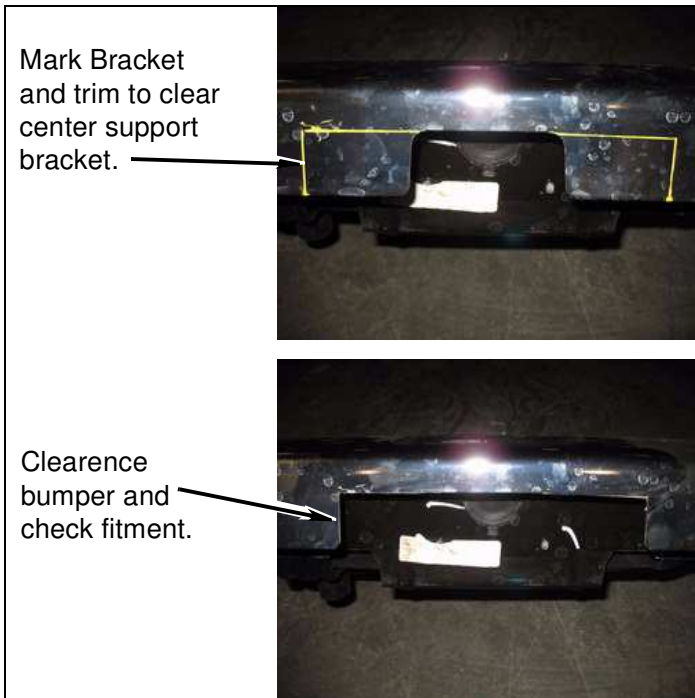

- e. Install rear bumper onto **kit bracket** (rear bumper, middle) with two **kit bolts** (7/16" x 1-1/2"), four **kit washers** (7/16" USS) and two **kit nuts** (7/16" Nylock). DO NOT TIGHTEN.

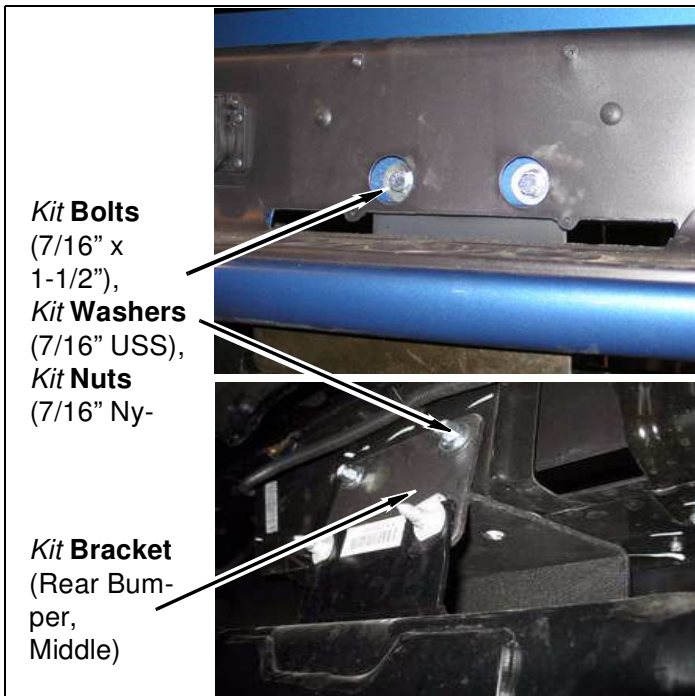

- f. Install **kit brackets** (rear bumper) onto bumper with two factory bolts on each side. DO NOT TIGHTEN.

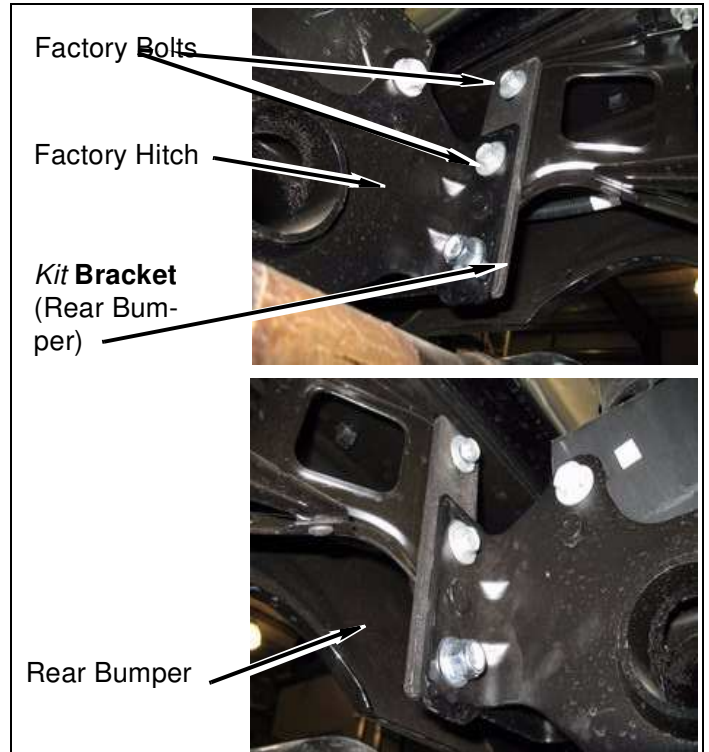

- g. Align rear bumper to previous bed-to-bumper measurements. TIGHTEN all hardware.

- h. Connect wiring harnesses to bumper.

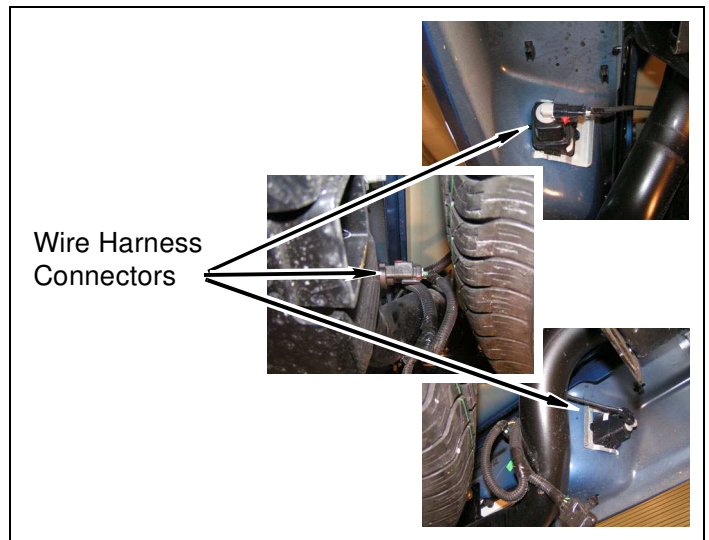

- i. Install license plate onto bumper with two factory screws.

Underside of Vehicle

1. Crush blocks

⚠ WARNING

A certified welder should perform all welding.

- Weld two **kit blocks** (3" crush) onto passenger side frame, below bed, where shown.

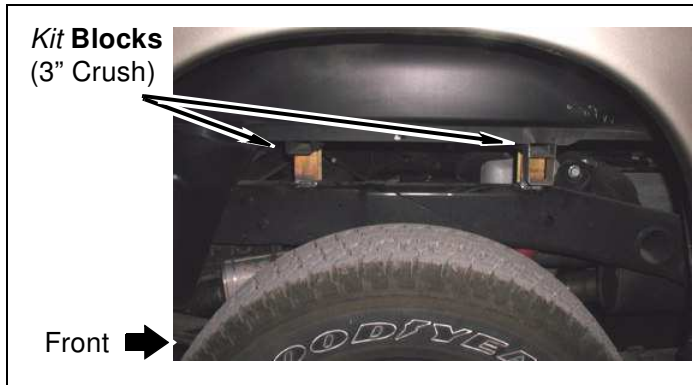

- Repeat above step for driver side.

⚠ WARNING

Use extreme caution when working near the fuel lines and the fuel tank. Clean up spilled fuel immediately. A spark could cause an explosion or fire resulting in serious personal injury and property damage.

2. Fuel filler

- Tighten gas cap.

3. Parking brake cable

- Reinstall Parking brake cable.

4. Ground strap

- Install ground strap onto **kit bracket** (3" ground, big hole) with **kit bolt** (1/4"-20 x 1"), two **kit washers** (1/4"-20 x 1") and **kit nut** (1/4"-20 Nylock)

- Install wire harness to body mount bracket on driver side with clip. .

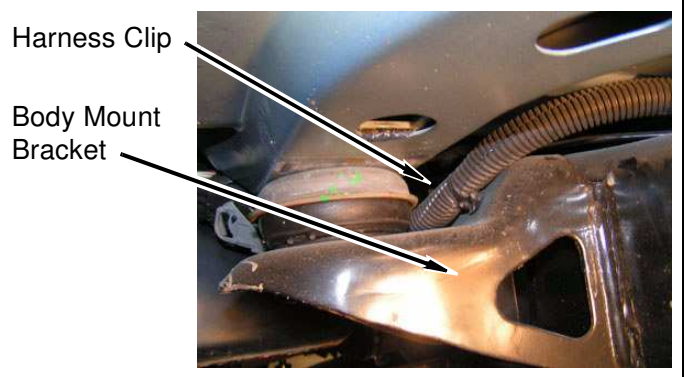
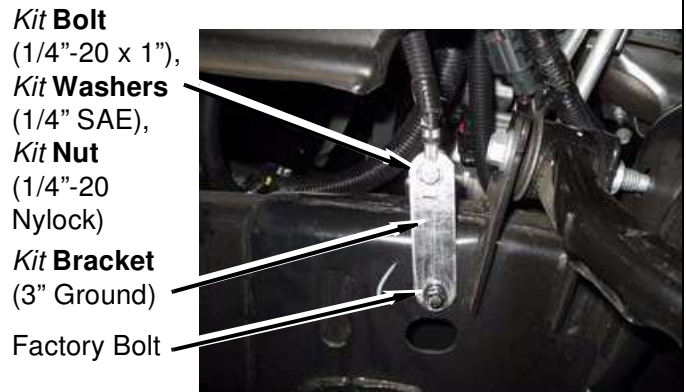

6. Brake line bracket

- Install two **kit brackets** (C-shaped) onto driver side frame with two bolts.
- Install brake line bracket onto to **kit brackets** (C-shaped) with two **kit bolts** (1/4" x 1"), four **kit washers** (1/4" SAE), and two **kit nuts** (1/4" Nylock).

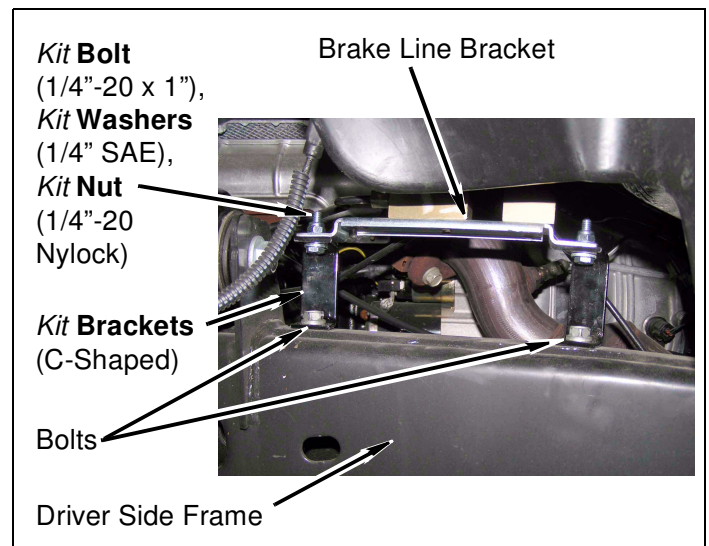

7. Install transmission wire harness on frame mount clip.

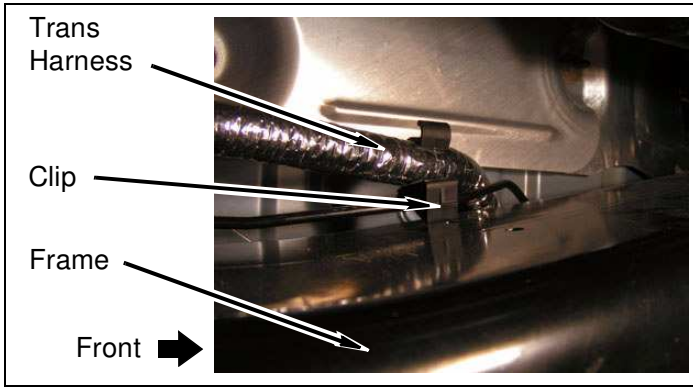

Inside of Vehicle

⚠ WARNING
 DO NOT DAMAGE any of the parts attached to the shift levers during cutting and/or welding. Damage to the shift lever equipment could result in serious injury or property damage.

⚠ WARNING
 A certified welder should perform all welding.

1. Manual transmission shift lever
 - a. Scribe a line along side of transmission shift lever (below lowest bend). Cut lever into two pieces and deburr as necessary.

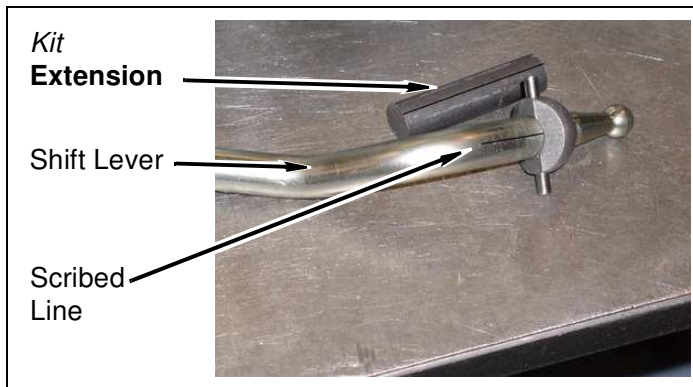

- b. Scribe a line along side of **kit extension** (shift lever). Position **kit extension** between two pieces of transmission shift lever. Ensure scribed lines on **kit extension** and transmission shift lever align. Weld **kit extension** into place.

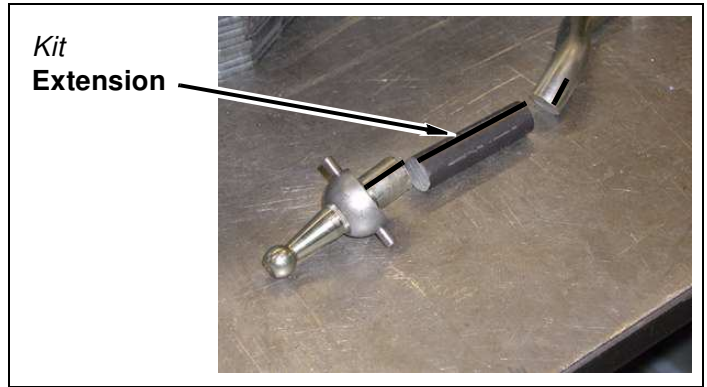

- c. Grind welded surfaces smooth in order to install mounting plate and shim to shift lever.

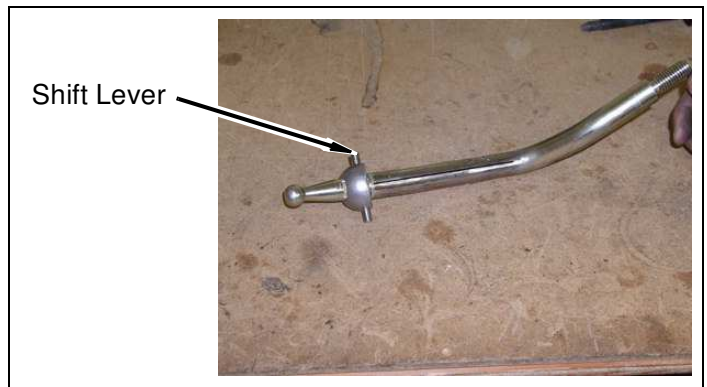

- d. Install two plastic shift tabs, plastic ball, shim and mounting plate onto shift lever.

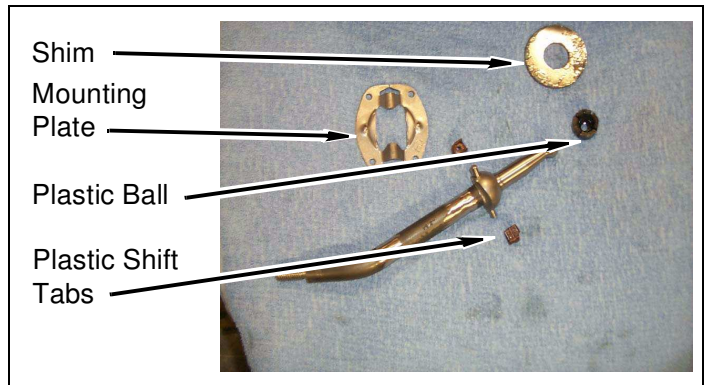

- e. Install shift lever onto shift tower with four Torx bolts.

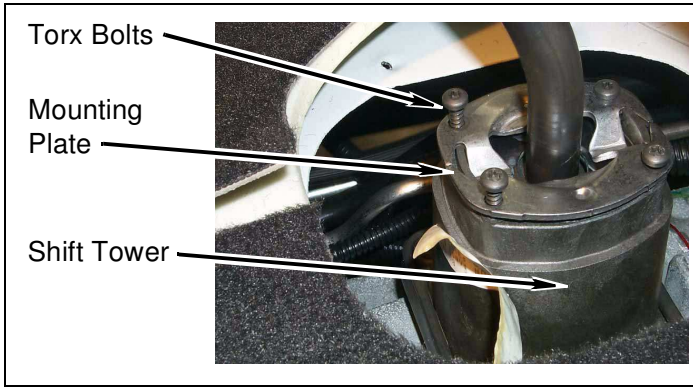

- f. Install rubber cover onto shift tower.

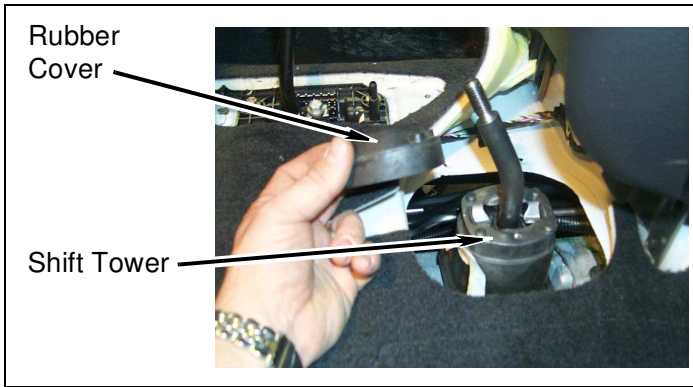

- g. Install shift lever boot seal onto floor with six bolts.

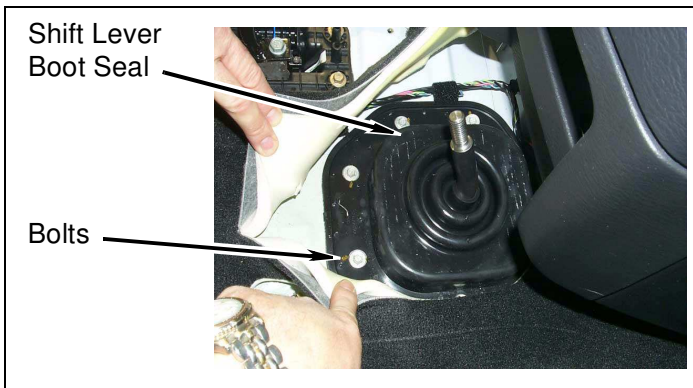

- h. Install center console onto floor with bolts.

- i. Screw transmission shift lever onto shift tower level.

- j. Install bolts securing center console to floor.

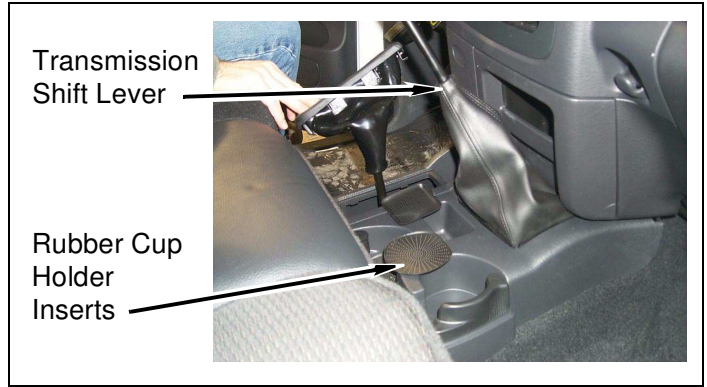

- k. Replace rubber cup holder inserts into center console.

- l. Check transmission shift lever operation. Ensure there is complete engagement in all gears.

Engine Compartment

- 1. Steering shaft



⚠ WARNING

Verify the steering extension is securely installed as specified in the instructions. Failure to do so may cause steering malfunction, resulting in property damage or serious personal injury.

- a. Install *kit extension* (steering) in position on rack and pinion. Ensure marks on rack and pinion and intermediate shaft are aligned.

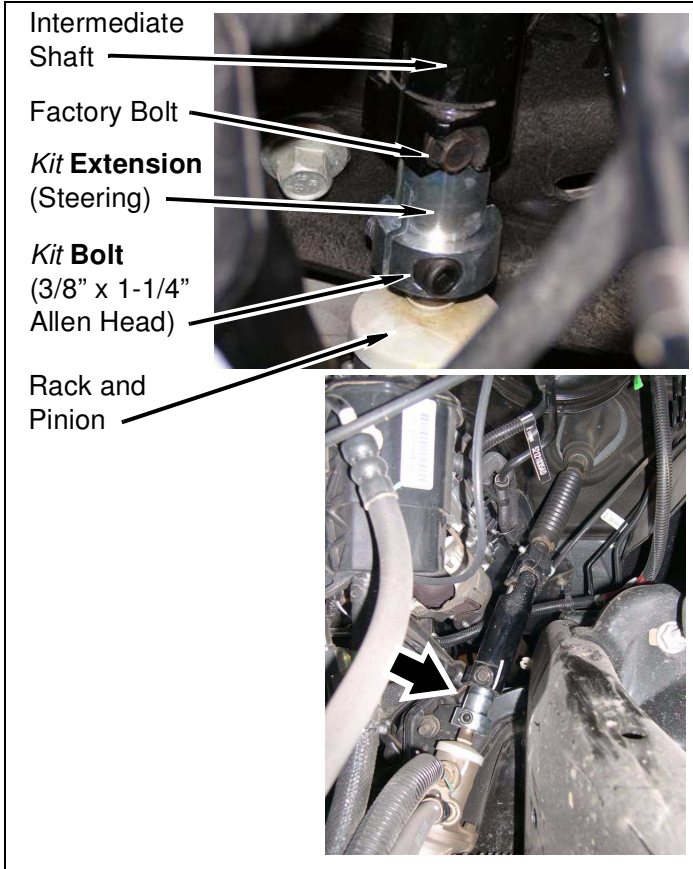

- b. Install intermediate shaft on *kit extension* (steering), ensuring marks on intermediate shaft and rack and pinion are aligned.
- c. Apply a few drops of *kit Loctite*® to factory bolt and *kit bolt* (3/8" x 1-1/4" Allen head).
- d. Install and TIGHTEN bolts to **33 lb.-ft.**

2. If possible, install brake sensor harness on passenger and driver fender wells.

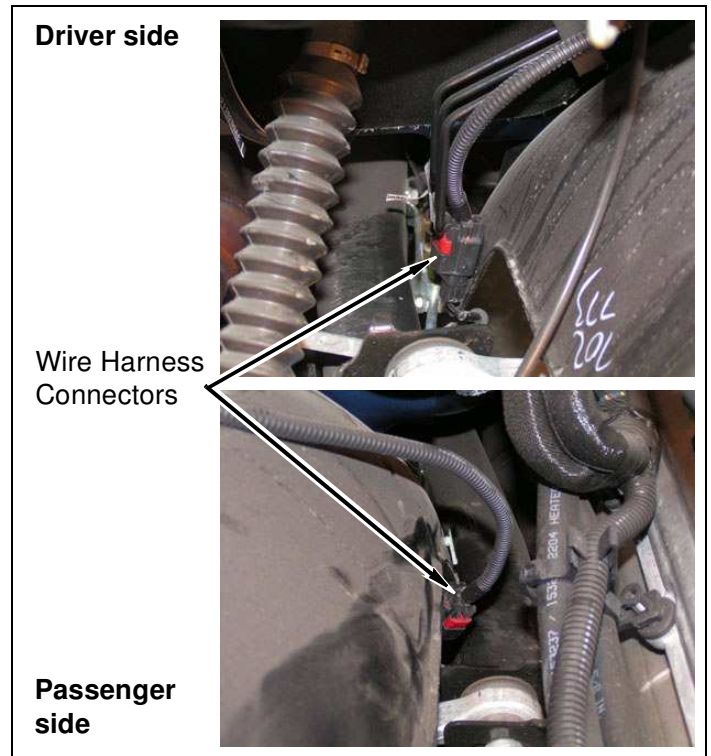

3. Fan shroud
 - a. Be sure that the fan clears the fan shroud.
4. Airbox
 - a. Install airbox cover, base and filter on vehicle.

- b. Install airbox cover onto airbox base with four clips. Install breather hose on airbox cover. TIGHTEN airbox hose clamp at intake housing.

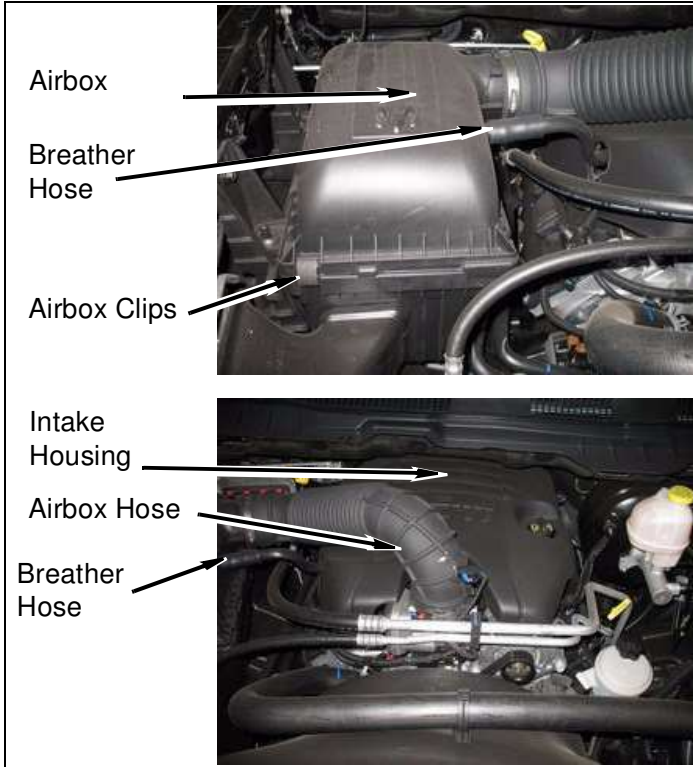

- b. Place new frame brackets behind the frame horn. Center the holes, use 1/2" hardware two secure The brackets to the factory frame. Do NOT TIGHTEN..

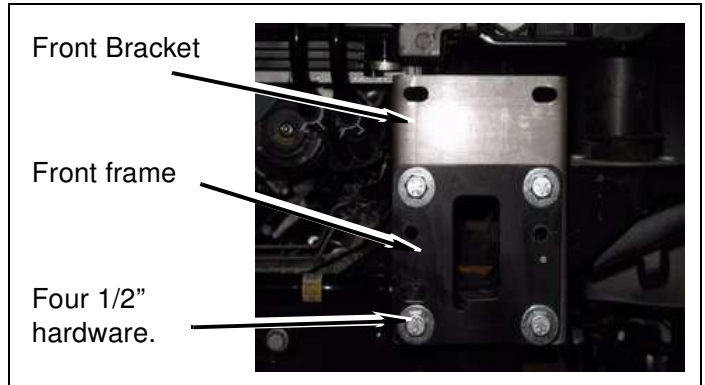

- c. Chrome bumper only: Place two 5/8 washers on drivers side top stud on bumper. Then use one 5/8 washer on each lower stud(Between bumper and bracket). Use your factory nuts on the studs. NOTE: Non-Chrome bumper use three 5/8 washers on top and two on each lower stud.
- d. Apply a few drops of *kit* **Loctite**® onto threads of studs. Align bumper, then tighten all hardware.

Front of Vehicle

- 1. Front bumper

⚠ CAUTION
 Factory supplied front two hooks CAN NOT be used, if equipped.

- a. Place new front bracket over driver frame horn, clamp it in place. Mark and drill two 1/2" holes(Centered) where marked(Be sure that everything is square). NOTE: Non-Chrome bumper will need to be drilled to 9/16". Repeat to passenger side. .

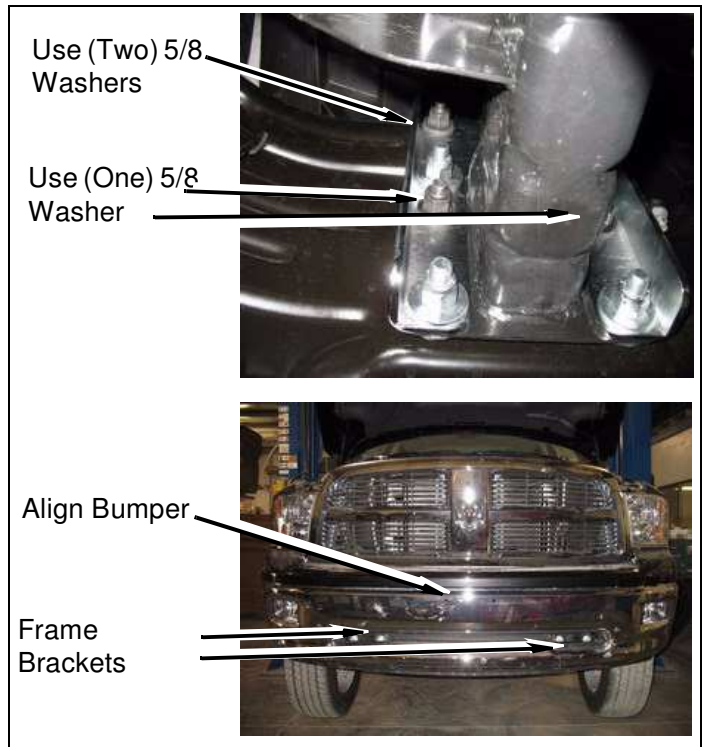
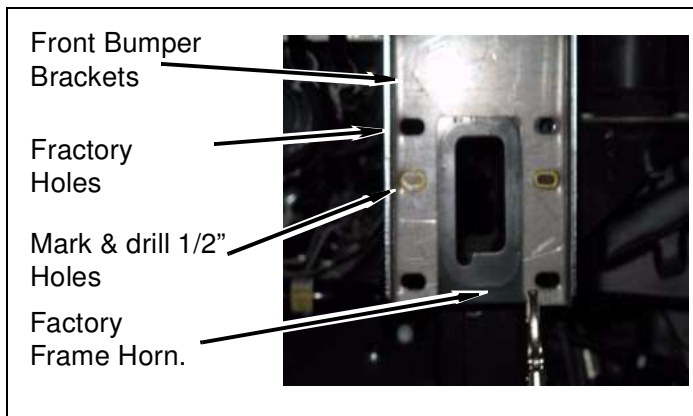

- e. Install front grill brace with factory hardware.
- f. Install trim peace over bumper gill support. Install each bolt at each corner(Under inner fender cover). Ensure both edges of fender well fit on backside of bumper edge.

g. Install front grill using factory hardware.

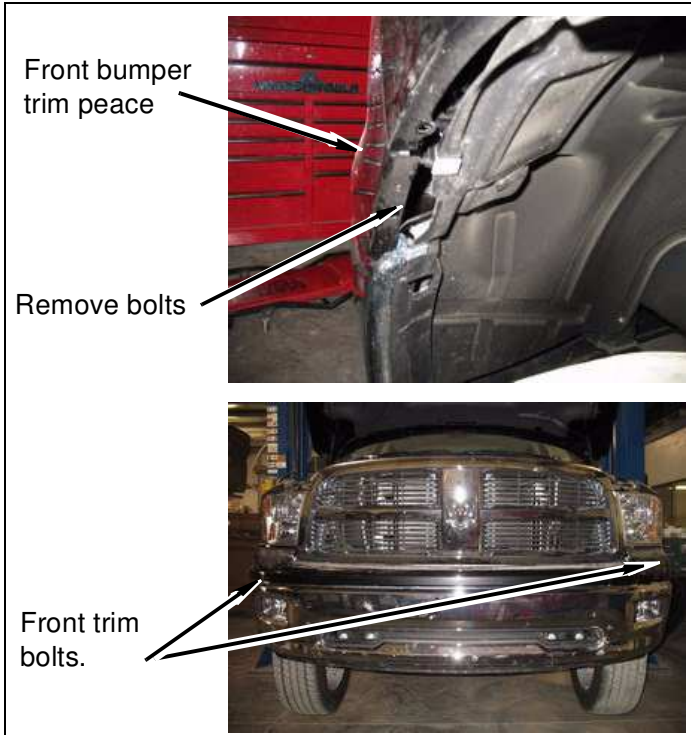

h. Connect fog light harness at driver side of front bumper and install onto front bumper, if equipped.

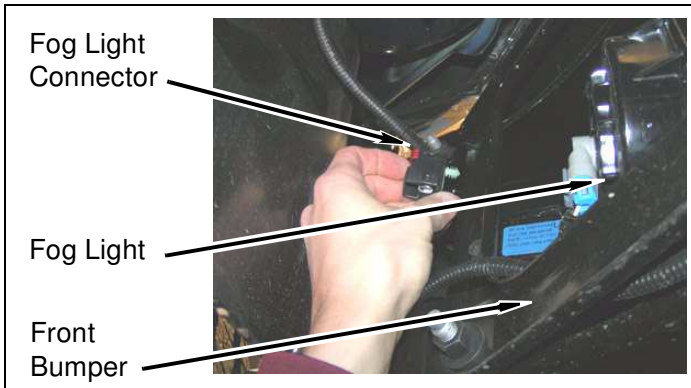

i. **2009:** Install push clips and lower splash guard on bumper, core support, and fan shroud.

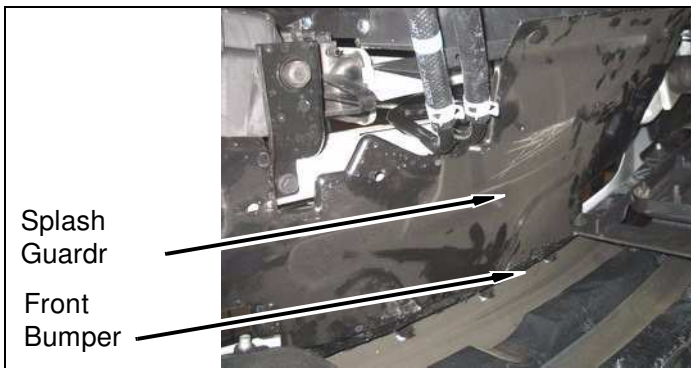

After Completing Installation

Engine Compartment

1. Airbag fuse

⚠ NOTE

The location of the airbag fuse may vary; check the owner's manual.

a. Install airbag fuse(s).

b. Install fuse cover.

2. Connect both battery cables. Connect positive cable first, then negative cable.

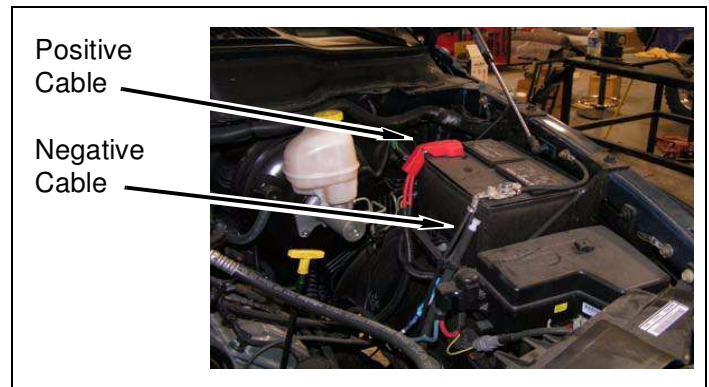

Miscellaneous

1. Apply **kit label** (warning) to dashboard in plain sight of all vehicle occupants.

2. Check all fasteners to ensure they are tight.

3. Ensure all wires, hoses, cables, etc. are properly connected and there is ample slack.

Dynamic Vehicle Check

1. Test-drive vehicle. Check steering in both directions to ensure that there is no bind. Check operation of clutch, brake system, and parking brake. Check operation of transmission and transfer case. Ensure there is full engagement in all gears and 4WD ranges. Check battery connections and electrical component operations.

⚠ WARNING

Retorque all fasteners after 500 miles and after off road use. All body lift components should be visually inspected and fasteners retorqued during routine vehicle servicing.

⚠ CAUTION

Performance Automotive Group does not recommend any particular wheel and tire combinations for use with its body lifts and cannot assume responsibility for the customer's choice of wheels and tires. Refer to your owner's manual for recommended tire sizes and warnings related to the use of oversized tires. Larger wheel and tire combinations increase stress and wear on steering and suspension components, which leads to increased maintenance and higher risk for component failure. Larger wheel and tire combinations also alter speedometer calibration, braking effectiveness, center of gravity, and handling characteristics. Consult an experienced local off road shop to find what wheel and tire combinations work best with your vehicle.

NOTE

All warranty information, instruction sheets, and other documents regarding the installation of this product must be retained by the vehicle owner. Information contained in the instructions and on the warranty card will be required for any warranty claims. The vehicle owner needs to understand the modifications made to the vehicle and how they affect vehicle handling and performance. Failure to provide the customer with this information can result in damage to the vehicle and severe personal injury.

Accessories

The following accessories are also available:

Kit # 6627: Gap Guards



⚠ NOTE

Depending on the vehicle configuration (automatic or manual transmission, 2WD or 4WD, cab length, bed length, etc.), some parts may not be used.

Kit Parts List

Qty. Description

16	Block (3" x 3" spacer)
4	Block (3" crush)
3	Bolt (1/4"-20 x 1-1/4")
1	Bolt (3/8"-16 x 1-1/4" Allen head)
6	Bolt (12mm-1.50x 100mm)
10	Bolt (12mm-1.75 x 180mm)
2	Bolt (5/16" x 1")
2	Bolt (7/16" x 1-1/4")
10	Bolt (1/2" x 1-1/4")
3	Nut (1/4" Nylock)
1	Nut (5/16" Nylock)
2	Nut (7/16" Nylock)
10	Nut (1/2" Nylock)
6	Washer (1/4" SAE)
2	Washer (5/16" USS)
20	Washer (7/16" USS)
24	Washer (1/2" USS)
2	Bracket (C-shaped)
1	Bracket (front bumper, driver)
1	Bracket (front bumper, passenger)
1	Bracket (ground strap, big hole)
1	Bracket (rear bumper, driver)
1	Bracket (rear bumper, passenger)
1	Bracket (rear bumper, middle)
1	Bracket (winch)
1	Extension (steering)
1	Extension (shift lever)
1	Label (logo)
1	Label (warning)
1	Label (warning, rear bumper)
1	Loctite® (6ml bottle)