

Work Truck Step Installation Instructions for Chevy Cargo Van

Part No's: 501040 / 501050

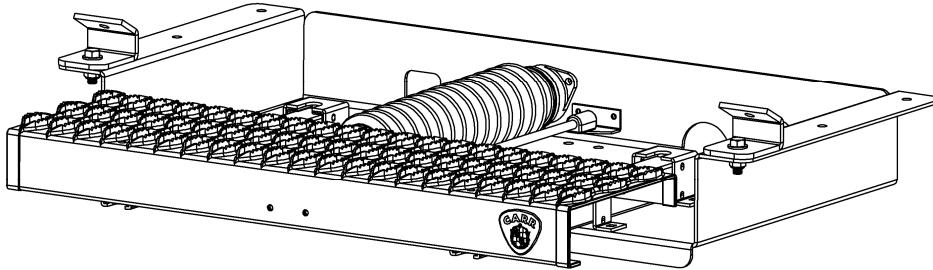

1. Mount the "C" shape steel brackets to the pan with 5/16" hardware provided and securely tighten them to the pan. Use the two 1" long 5/16" bolts for these brackets.



2. Clamping Brackets

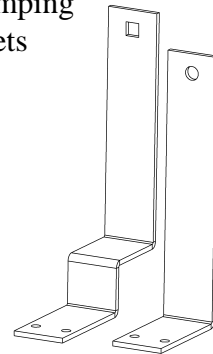

3. Place the clamping brackets alongside the frame using the 1/2" hardware provided and hand tighten. Make sure the clamp assembly is up against the rubber muffer assembly. This alignment is critical for the step to be in its proper location.

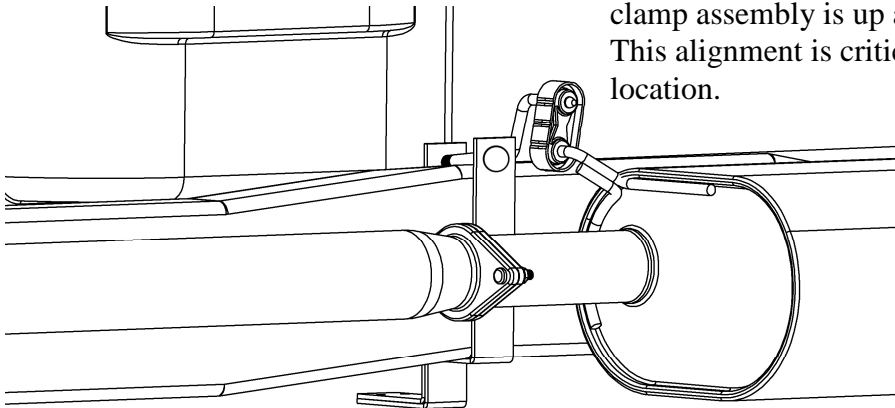

4. Take 2-5/16" X 1" hex bolts with 4 washers and 2 nylon lock nuts with the step assembly resting on the Clamping Brackets securely tighten step assembly to the clamping brackets. Head of bolts will be inside the pan. **IMPORTANT:** Make sure that the clamping assembly is up against the rubber muffer assembly. Now take your 3/4" wrench and securely tighten the 1/2" nylon lock nut to the 1/2" Carriage bolt.

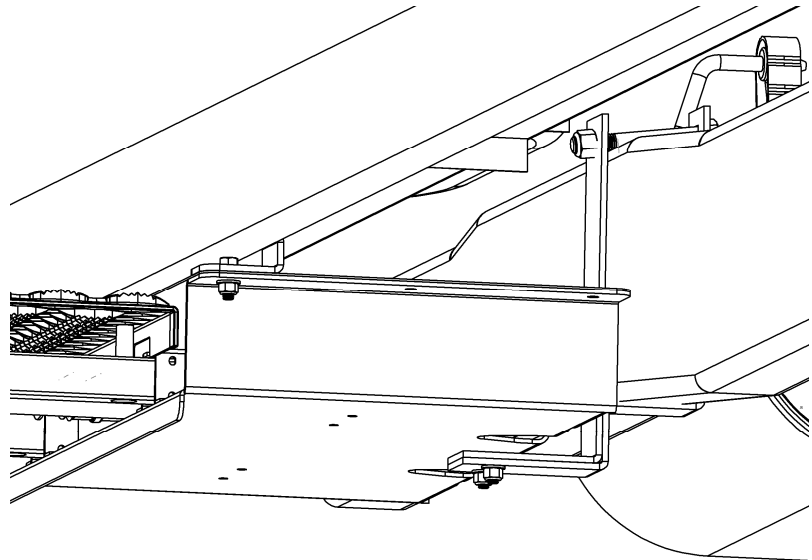

Work Truck Step Installation Instructions for Chevy Cargo Van Part No's: 501040 / 501050

5. With the "C" shaped steel brackets resting on the rocker panel, mark two sets of lines with a pencil on the outside of the body metal that line up with edges of each "C" shaped steel bracket. Measure in $\frac{1}{2}$ " from the edge of the rocker panel and mark a line between both sets of lines you have just marked. Mark another line exactly between the lines you first marked. You now have a cross-hair. Center-punch these areas and drill out with a $\frac{5}{16}$ " drill bit.

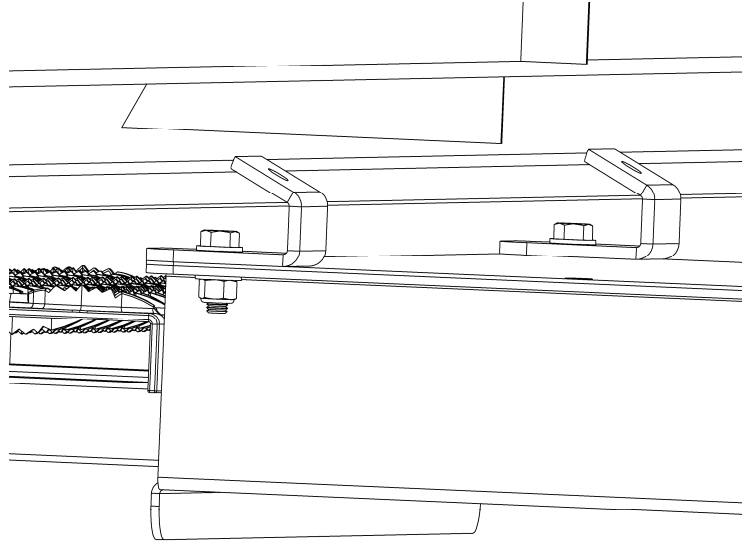

6. Take the two 1" long $\frac{5}{16}$ " bolts with washers and nylon lock nuts and securely tighten the "C" shaped steel brackets to the vehicle's rocker panel.

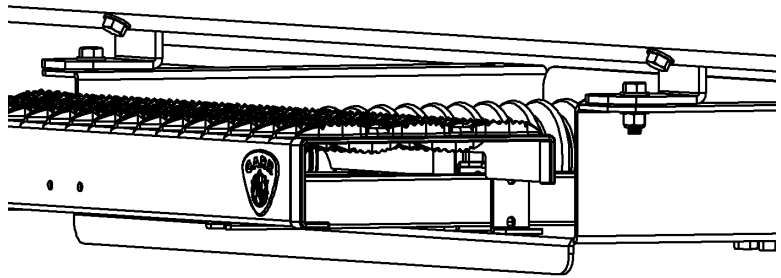

7. Remove the bolt assemblies that hold the "C" shaped steel brackets to the pan. Take the cover plate and slide it between the pan and the "C" shaped steel brackets. Align the holes and reinstall the bolt assemblies just removed. Take the remaining $\frac{5}{16}$ " X $\frac{3}{4}$ " bolts with washers and nylon lock nuts and securely tighten the cover plate to the pan.

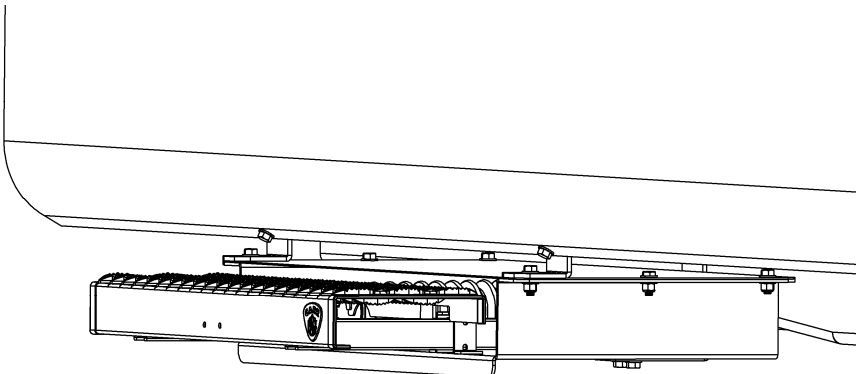
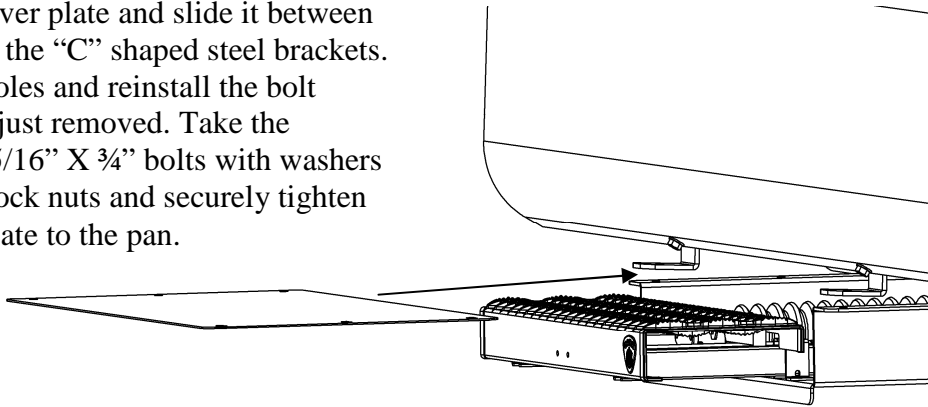

8. Fully assembled unit

Work Truck Step Installation Instructions for Chevy Cargo Van

Part No's: 501040 / 501050

WARNINGS!

- ✓ FOR SAFE AND PROPER USAGE OF THIS PRODUCT, THE MOUNTING INSTRUCTIONS MUST BE FOLLOWED CAREFULLY AND COMPLETELY.
- ✓ The manufacturer and distributor of this product are in no way responsible for the consumer's failure to adhere to the warnings and directions of these instructions in the event of damage to the consumer's vehicle, other properties and or personal injury.



Quality and Style that Endures

Follow the diagram and the written directions carefully for a proper, safe installation.

Should you encounter an unusual, unforeseen problem, contact our Technical Help Line
7:00 AM – 3:00 PM Pacific

Time

(800) 800-1084

Visit our web-site at

www.CARR.com

Carr Pattern Co., Inc.

Vehicle Application:

'03-'15 Chevy Cargo Van

MATERIALS NEEDED:

- * Drill motor
- * 5/16 drill bit
- * Pencil
- * Center punch
- * 2 – 1/2" wrenches or sockets
- * 1 – 3/4"
- * Cutters to cut zip ties

MATERIAL FURNISHED:

- * Step Assembly
- * 2 – Clamping Brackets
- * 2 – "C" shaped steel brackets
- * 1 – Cover Plate
- * Hardware installation pack
- * Instruction sheet

Carr Pattern Co., Inc. Warranty Policy

Finishes: Limited Lifetime

Structural Warranty: Limited Lifetime

Warranty Conditions:

- All warranties start from consumer's date of purchase.
- A new product will be sent out immediately to replace a warranty claim.
- The above guidelines apply only to the Original Purchaser.
- Original proof of purchase must be submitted for all warranty and returns issues.

Warranty Limitations:

- Warranty coverage extends ONLY to repair or replacement of the CARR product. This warranty does not cover the cost of labor, transportation, installation or removal of the product.
- Warranty coverage does not extend to damage caused by: collision, fire, theft, freezing, vandalism, riot, explosion or object striking the product, or misuse of the product and/or the vehicle on which the product is being installed.
- Warranty coverage does not extend to damage caused by: airborne fallout (chemicals, tree sap, etc.), stones, hail, earthquake, water or flood, windstorm, lightning, the application of chemicals or sealants subsequent to manufacture.
- Warranty coverage does not extend to damages caused by: normal wear and tear, abuse, modification or improper installation of the product.
- Warranty coverage does not extend to any economic loss or extra expense including (without limitation), payment for the loss of time or pay, inconvenience, storage, loss of vehicle use, vehicle rental expense, equipment rental expense, lodging, meals, or other travel costs.

Other Terms:

This warranty gives you specific legal rights and you may also have other rights that vary from state to state. CARR does not authorize any person to create for it any other obligation or liability in connection with its products. ANY IMPLIED WARRANTY OF MERCHANTABILITY OR FITNESS FOR A PARTICULAR PURPOSE APPLICABLE TO THIS PRODUCT IS LIMITED IN DURATION TO THE DURATION OF THIS WRITTEN WARRANTY. PERFORMANCE OF REPAIRS AND NEEDED ADJUSTMENTS IS THE EXCLUSIVE REMEDY UNDER THIS WRITTEN WARRANTY OR ANY IMPLIED WARRANTY. CARR SHALL NOT BE LIABLE FOR INCIDENTAL OR CONSEQUENTIAL DAMAGES RESULTING FROM BREACH OF THIS WRITTEN WARRANTY.*

*Some states do not allow limitations on how long an implied warranty will last or the exclusion or limitation of incidental or consequential damages, so that above limitations or exclusions may not apply to you.

Guarantee: Every attempt has been made to manufacture and distribute the finest quality products available. Our manufactured products are guaranteed to be free of defects due to workmanship or materials. Distributed products are subject to manufacturer's warranty only.