



Installation Instructions

Chevy HD Replacement Bumper

Product Number: S2050
Application: '07.5-Current Chevy 2500-3500 HD
(Non-Classic)

SAFETY

Your safety and the safety of others is very important.

- In order to help you make informed decisions about safety, we have provided installation instructions and other information.
- These instructions alert you to potential hazards that could hurt you or others.
- Please do a job safety analysis (JSA) before each task to identify potential hazards for your situation and remove/protect against them.
- You must use your own good judgment, and take your time.

Read and understand all safety precautions and instructions before installing this product.

THIS PRODUCT IS FOR OFFROAD USE ONLY. ALL LIABILITY FOR INSTALLATION AND USE RESTS WITH THE OWNER.

CARELESS INSTALLATION AND OPERATION CAN RESULT IN SERIOUS INJURY OR EQUIPMENT DAMAGE.

Injury hazard

Failure to observe these instructions could lead to severe injury or death.

- Always** remove jewelry and wear eye protection.
- Always** use extreme caution when jacking up a vehicle for work. Set emergency brake and use tire blocks. Locate and use the vehicle manufacturers designated lifting points. Use jack stands.
- Always** use appropriate and adequate care in lifting components into place.
- Always** insure components will remain secure during installation and operation.
- Always** wear safety glasses when installing this kit. A drilling operation will cause flying metal chips. Flying chips can cause serious eye injury.
- Always** use extreme caution when drilling on a vehicle. Thoroughly inspect the area to be drilled (on both sides of material) prior to drilling, and relocate any objects that may be damaged.
- Always** use extreme caution when cutting and trimming during fitting.
- Always** tighten all nuts and bolts securely per installation instructions.
- Always** route electrical cables carefully. Avoid moving parts, components that become hot and rough or sharp edges.
- Always** insulate and protect all exposed wiring and electrical terminals.
- Always** perform regular inspections and maintenance on mounts and related hardware.



Installation Instructions

Chevy HD Replacement Bumper

Product Number: S2050

Application: '07.5-Current Chevy 2500-3500 HD
(Non-Classic)

I. Overview

Congratulations on your purchase of the industries' best and most stylish Chevy Replacement Bumper! This bumper has been **engineered** for strength while keeping the weight down.

Your bumper was designed in 3-D from digitized data, CNC laser cut, fabricated, and powder coated... all in the U.S.A.

Enjoy the fit and finish of a quality Chevy Replacement Bumper from Fab Fours Inc!

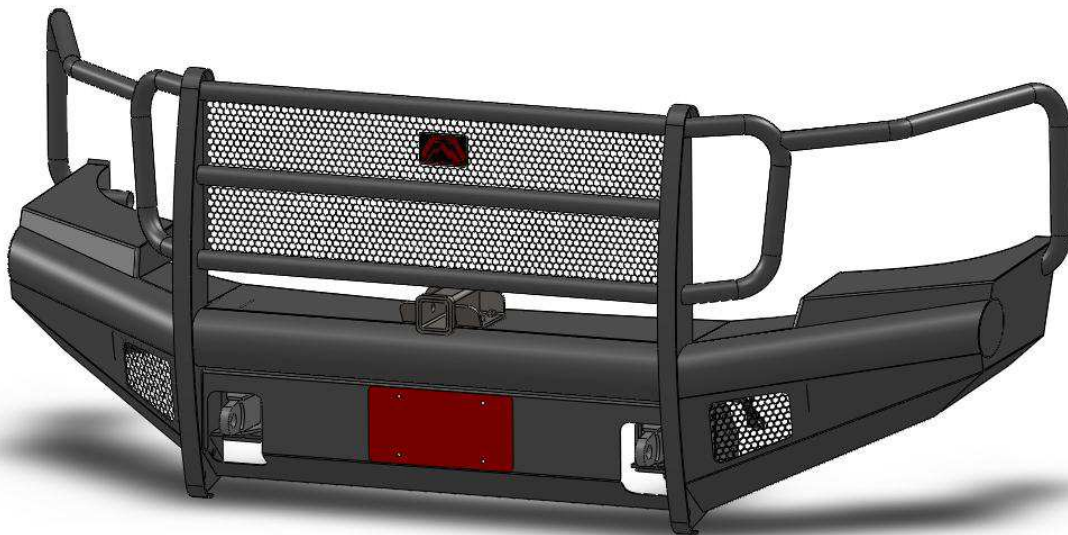



Installation Instructions Chevy HD Replacement Bumper

Product Number: S2050

Application: '07.5-Current Chevy 2500-3500 HD
(Non-Classic)

II. Tools Required

- Socket Wrench with Extension
- 7/32", 3/4", 10mm, 15mm, 18mm, 21mm Sockets
- 3/8", 7/16", & 3/4" Box End Wrench
- Phillips Screwdriver
- Floor Jack and wood block.

III. Vehicle Preparation

A. Disconnect the factory fog lamp connectors (If Applicable), zip tie harness to frame.

B. Remove bolts and swing outer bumper support tubes down and out of the way, using a 15mm socket. Two Bolts per side. See Image Below

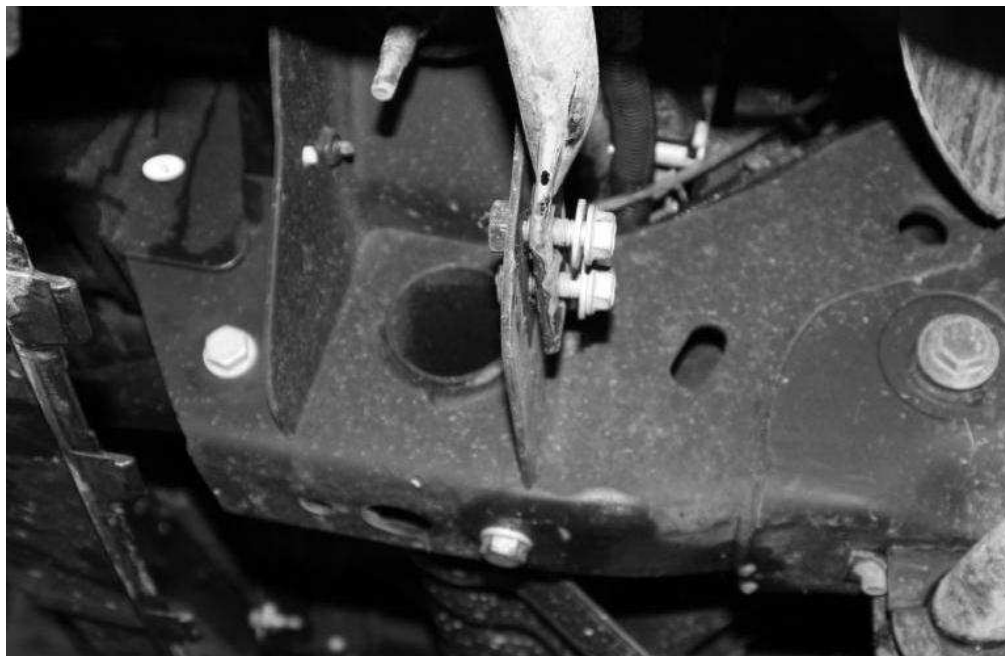



Installation Instructions Chevy HD Replacement Bumper

Product Number: S2050

Application: '07.5-Current Chevy 2500-3500 HD
(Non-Classic)

C. Remove the dart clips holding the rubber valance between the frame and the bumper.

D. Remove 21mm nuts(2 Per Side) from the bolt strips holding the bumper brackets to the frame. **NOTE: SUPPORT BUMPER BEFORE REMOVING BOLT STRIPS!** See Image Below.



E. With the bumper supported remove the bolts strip holding the bumper to the frame.

F. Pull outward slightly at the fender wells and remove the bumper from the front.

G. With Bumper removed from the truck, remove the 18mm bolts attaching the Factory Tow Hooks to the frame. Remove the tow hooks.

H. Your Truck is now ready for the installation of your New FAB FOURS BUMPER!



Installation Instructions Chevy HD Replacement Bumper

Product Number: S2050

Application: '07.5-Current Chevy 2500-3500 HD
(Non-Classic)

IV. Bumper Installation

NOTE: The Following Installation steps apply to the installation of the Bumper to the vehicle. PLEASE READ THE ENTIRE MANUAL BEFORE ATTEMPTING INSTALLATION! Ignoring these steps will increase your probability of scratching the vehicle during product Installation!

1. Remove the Bumper from the shipping carton. Lay all items out on a blanket to prevent damage to the powder coating. Install lower guard (***IF INSTALLING A WINCH SEE WINCH TRAY INSTALLATION INSTRUCTIONS***) by rotating it into position from the bottom of the bumper as shown below. Install three ½" fasteners (Provided in hardware bag labeled 20260-HW) per side with bolt heads facing the inside of the bumper.

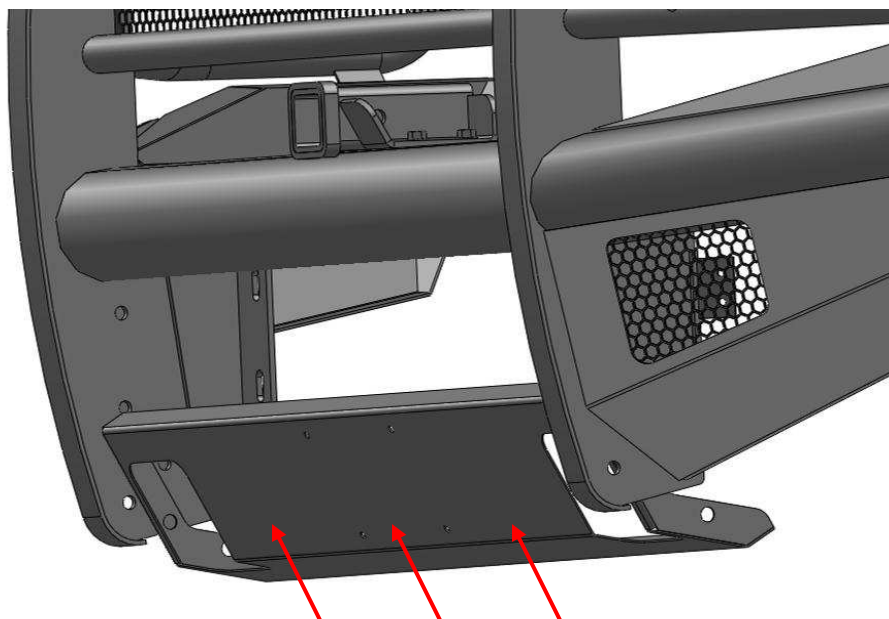

Figure 1 - Lower Guard Installation



Installation Instructions Chevy HD Replacement Bumper

Product Number: S2050

Application: '07.5-Current Chevy 2500-3500 HD
(Non-Classic)

- OPTIONAL:** If you wish to retain the stock fog lamps, remove the lights from the stock bumper and reinstall using OEM hardware in the provided brackets behind the protective mesh. It may be necessary to remove the adjuster screw prior to installation. With the fog light clipped in the bracket, reinstall the adjuster screw to clamp the light in place.
- OPTIONAL:** If installing your bumper with D-ring shackle mounts, they should be placed inside the bumper mounting brackets before final installation. Insert the shackle mounts from the front of the bumper as shown below.

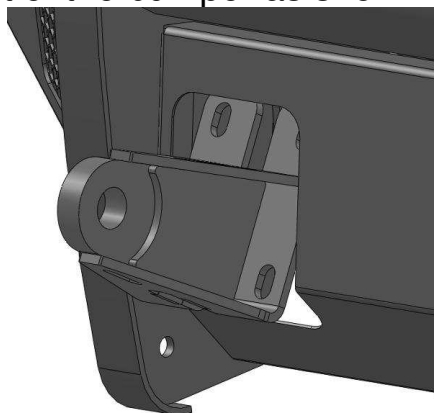

Figure 2 - Shackle Bracket Installation

- OPTIONAL:** If installing the 2" receiver hitch accessory, attach it to the bumper with the provided 1/2" hardware

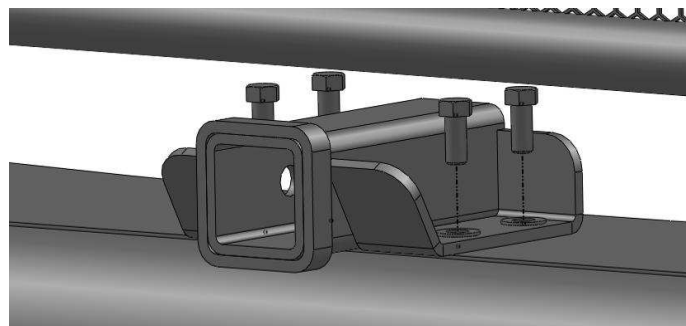

Figure 3 - Hitch Installation



Installation Instructions Chevy HD Replacement Bumper

Product Number: S2050

Application: '07.5-Current Chevy 2500-3500 HD
(Non-Classic)

Install intermediate brackets in the orientation shown below (larger offset to the outside of the truck) using the OEM mount locations. ***DO NOT TIGHTEN UNTIL BUMPER ASSEMBLY HAS BEEN INSTALLED AND ALIGNED.***

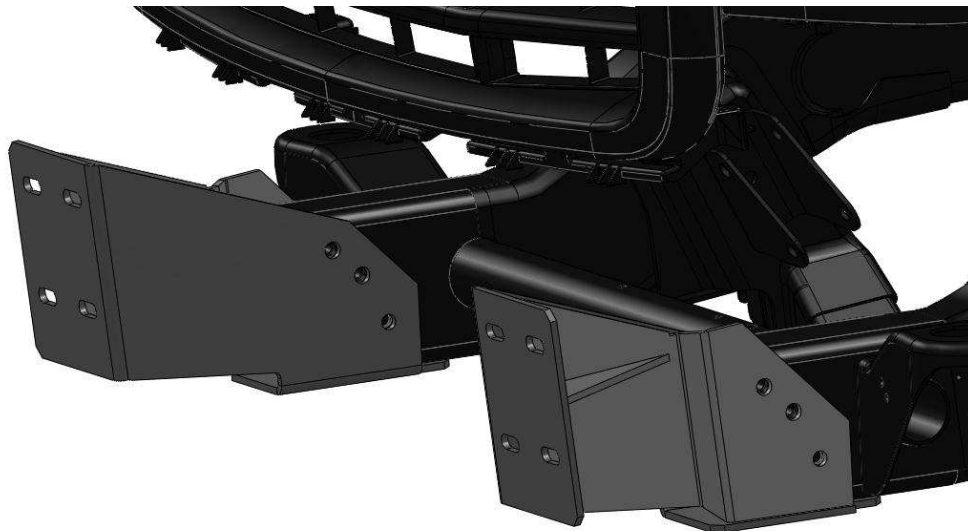

Figure 4 - Intermediate Bracket Orientation

5. Lift bumper and align mounting slots with the mating slots on the intermediate mounts. Install ½" mounting bolts but do not tighten fully. It may be helpful to support bumper with a floor jack(s) during install. Repeat for other side
6. Adjust the bumper to achieve good visual alignment as follows:
 - a. Adjust and up/down and left right alignment with the intermediate mount bolts
7. Tighten all fasteners; beginning with frame mounts. Then tighten all mount-to-bumper fasteners.
8. Trim inner-fender liners to match bumper if desired.



Installation Instructions Chevy HD Replacement Bumper

Product Number: S2050

Application: '07.5-Current Chevy 2500-3500 HD
(Non-Classic)

Install the Supplied Tow Hooks in the orientation shown below (Open to the inside and on the outside of the brace) using the supplied $\frac{1}{2}$ "-13 bolts, washers, and nuts.

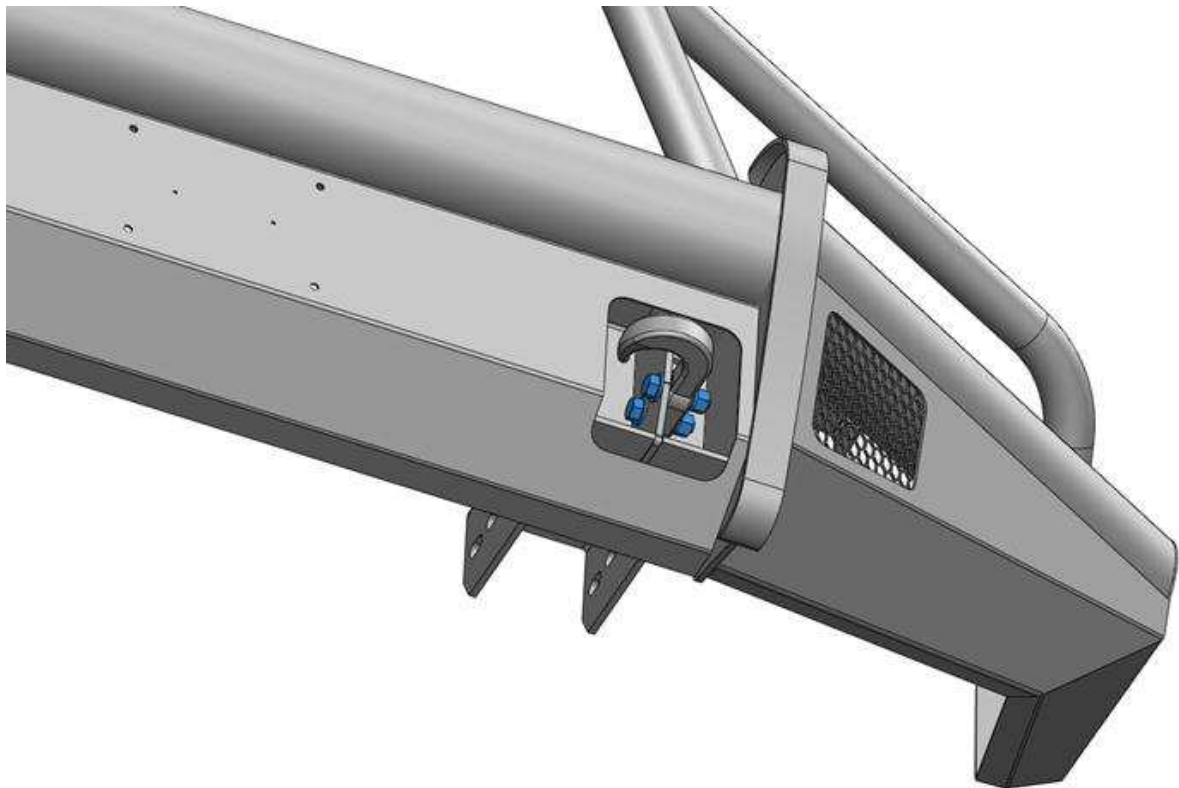



Installation Instructions Chevy HD Replacement Bumper

Product Number: S2050

Application: '07.5-Current Chevy 2500-3500 HD
(Non-Classic)

Installation Complete!

V. Maintenance/Care

- Check for loose fasteners after the first 100mi of driving (less for severe duty applications)
- Periodically check and tighten all fasteners.
- Stripped, fractured, or bent bolts or nuts need to be replaced.

VI. Contact Information

Fab Fours Inc.
1312 Camp Creek Rd.
Lancaster, SC 29720

Phone (866)-385-1905
Fax (970)-385-1914
Email Support@fabfours.com



More than expected... Better than expected