



INTAKE SYSTEMS FOR VEHICLES LISTED ARE 50 STATE LEGAL. SEE KNFILTERS.COM FOR CARB STATUS ON EACH PART FOR A SPECIFIC VEHICLE.

INSTALLATION INSTRUCTIONS

57-3081
CHEVROLET
2014-15 Corvette
V8-6.2L

TOOLS NEEDED:

- ratchet
- extension
- 10mm socket
- 7mm socket
- t25 torx
- philips screw driver
- flat blade screw driver
- pliers
- 3mm allen key
- 10mm wrench
- knife

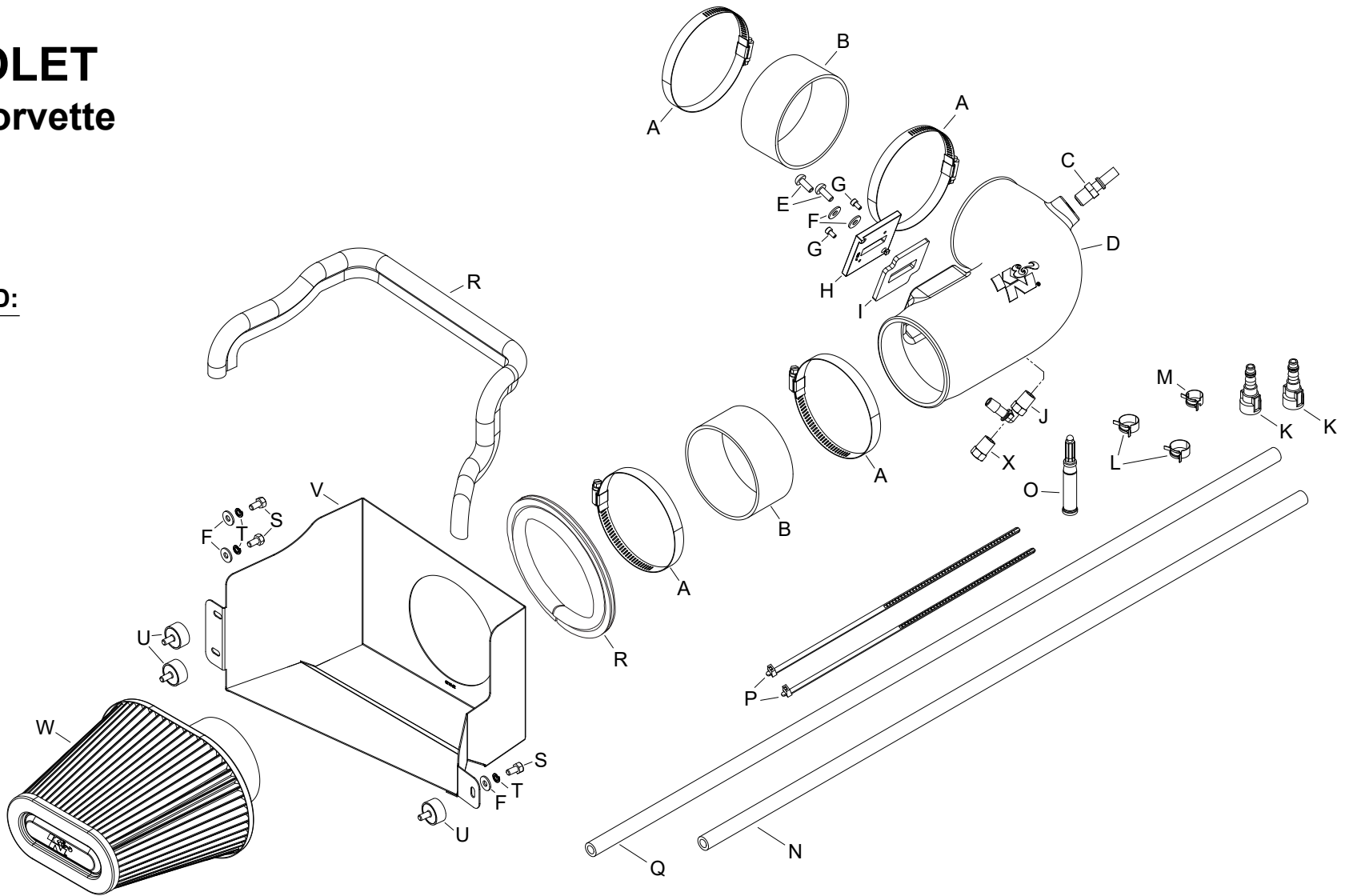

PARTS LIST:

Description	Qty.	Part #	Description	Qty.	Part #	Description	Qty.	Part #
A HOSE CLAMP #64, BLACK ZINC	4	08645K	I GASKET; 57-2556, 3/16 PORON	1	09069	Q HOSE; 3/8" ID X 40"L, VENT	1	08635
B HOSE; 4" ID X 2"L REIN.	2	08761	J VENT; 1/4NPT, 90 DEG, 3/8"	1	08523	R EDGE TRIM	1	102486
C VENT; STRT, 1/4" NPT	1	08938	K FITTING; 3/8"ID QUICK DISC.	2	082629	S BOLT; M6 X 1.00 X 12MM, SS	3	07727
D INTAKE TUBE	1	087275A	L HOSE CLAMP; SPRING BAND	2	08553	T WASHER; M6 SPLIT LOCK ZINC	3	1-3025
E BOLT; M6 X 1.00 X 16MM, SS	2	07730	M HOSE CLAMP; SPRING BAND	1	08552	U STUD; RUBBER MNT, M/F,	3	070228
F WASHER; 6MM FLAT,SS	5	08269	N HOSE; 3/8" ID X 38"L, REIN.	1	08636	V HEAT SHIELD	1	073162
G BOLT; M4-0.7 8MM, A/H CAP	2	07733	O SUPER GLUE; 3G DRIP PROOF	1	409	W AIR FILTER	1	RP-5285
H ADAPTOR; 57-2556, NYLON	1	21515	P CABLE TIES, 11" BLACK	2	21590	X 1/4" NPT PLUG	1	08032

If you need any assistance please call 1-800-858-3333 to speak with a representative in our Customer Service Center before returning the product.

NOTE: FAILURE TO FOLLOW INSTALLATION INSTRUCTIONS AND NOT USING THE PROVIDED HARDWARE MAY DAMAGE THE INTAKE TUBE, THROTTLE BODY AND ENGINE.

TO START:

1. Turn off the ignition and disconnect the negative battery cable.
NOTE: Disconnecting the negative battery cable erases pre-programmed electronic memories. Write down all memory settings before disconnecting the negative battery cable. Some radios will require an anti-theft code to be entered after the battery is reconnected. The anti-theft code is typically supplied with your owner's manual. In the event your vehicles anti-theft code cannot be recovered, contact an authorized dealership to obtain your vehicles anti-theft code.

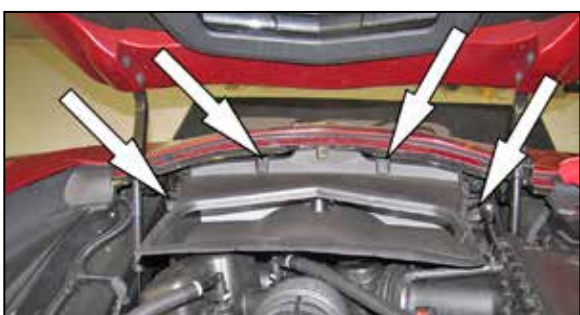

2. Remove the four bolts that secure the air extraction duct to the radiator and then remove the duct from the vehicle.



3. Release the grey locking tabs securing the crank case vent and oil tank vent tubes to the factory intake hoses and then disconnect the crank case hoses from the intake tube.
NOTE: Some vehicles may not have a vent line from the driver's side valve cover to the intake tube.



4. On vehicles that are equipped with a "Dry Sump" oiling system, release the grey locking tap securing the oil tank vent hose to the oil tank, then unhook the oil tank vent hose from the two retaining clips and remove the hose from the vehicle.
NOTE: On vehicles that are not equipped with the vent line from the driver's side valve cover to the intake tube, this step is not necessary.



4A. On vehicles equipped with a "Wet Sump" oiling system, disconnect the crank case vent hose from the passenger side valve cover port and remove the hose from the vehicle.



5. Disconnect the mass air sensor electrical connection.



6. Loosen the hose clamps that secure the factory intake tube to the throttle body and air filter housing and then remove the factory intake tube from the vehicle.

NOTE: K&N Engineering, Inc., recommends that customers do not discard factory air intake.



7. Loosen the two TORX fasteners securing the factory mass air sensor housing to the air filter housing and then remove the mass air housing and air filter from the vehicle.



8. Remove the two bolts that secure the air filter housing to the inner fender then unhook the housing from the mounting stud and remove the housing from the vehicle.

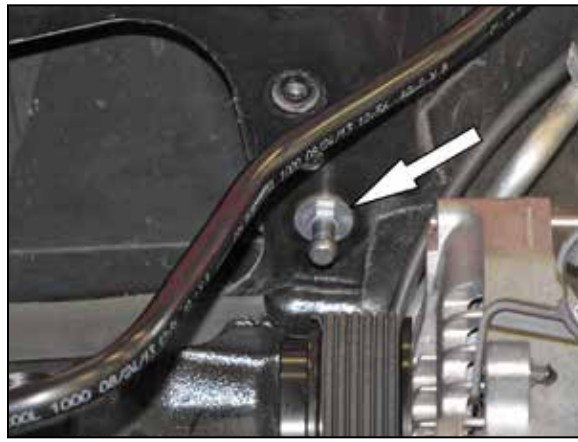

9. Remove the air box mounting stud from the inner fender.



10. Assemble the provided coolant hose (08636), quick disconnect fitting and clamps. Install one clamp 1.5" from the open end of the provided coolant hose.

NOTE: Slip joint pliers can be used to collapse the clamps for installation.



11. **WARNING: Be sure that the engine is cool before proceeding with this step!** Release the blue locking tab securing the factory coolant hose to the expansion tank and then disconnect the hose from the tank.

NOTE: Be sure to collect any coolant that may escape the tank or hose.

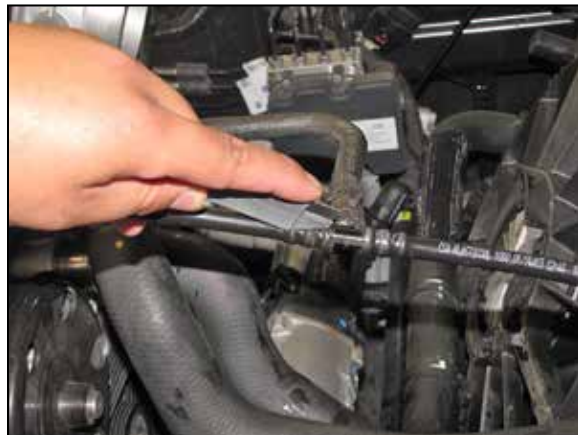

12. Using a razor knife, cut the plastic hose at the TEE fitting where shown. Separate the plastic hose from the TEE fitting.

NOTE: Be careful cutting the plastic hose so as not to cut too deep. It may be beneficial to make several shallow passes while cutting to prevent cutting into the TEE fitting. Be sure to capture any coolant that may leak out of the hose and TEE fitting.

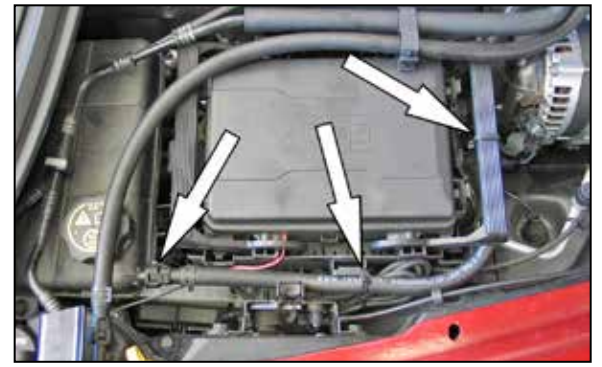

13. Install the provided coolant hose assembled from step #10 onto the expansion tank. Route the coolant hose and then attach the open end onto the TEE fitting and secure with the provided spring clamp. Use the provided tie wraps to secure the coolant hose.



14. Install the three provided rubber mounted studs onto the heat shield mounting location as shown.

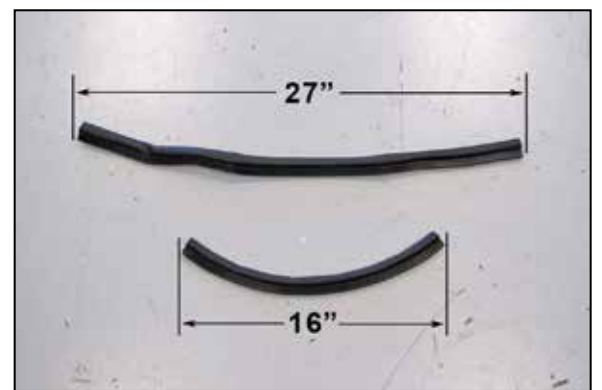

15. Cut the provided edge trim into two sections. One section should be 16" long, one section should be 27" long.

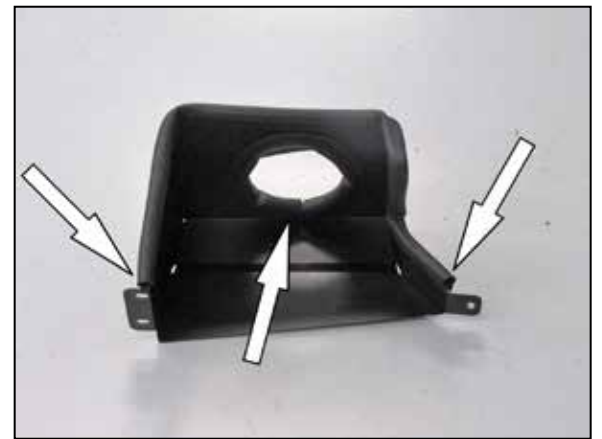

16. Install the 16" section into the hole of the heat shield and install the 27" section around the perimeter of the heat shield as shown.

NOTE: Use the provided super glue on the edge trim to hold down the ends next to the inner fender.



17. Set the air filter into the heat shield and then install the provided coupling hose (08761) onto the filter and secure with the provided hose clamp.



18. Install the heat shield assembly onto the rubber mounted studs and secure with the provided hardware.



19. Install the provided coupling hose (08761) onto the throttle body and secure with the provided hose clamp.



20. Remove the two screws securing the mass air sensor to the factory housing and then remove the sensor from the housing.



21. Install the provided gasket onto the K&N mass air sensor adapter as shown.



22. Install the mass air sensor into the provided adapter and secure with the provided hardware.



23. Install the mass air sensor assembly into the K&N intake tube and secure with provided hardware.

NOTE: Be sure to install the sensor in the correct direction. The open end of the sensor will point towards the air filter.



24. Install the provided vent fittings into the into the K&N intake tube as shown.

NOTE: On vehicles not equipped with the vent line from the drivers valve cover to the intake tube, install the 1/4" NPT plug into the location shown instead of the 90° vent fitting.

NOTE: Plastic NPT fittings are easy to cross thread. Install the vent fitting "hand" tight, then turn it two complete turns with a wrench.



25. Install the K&N intake tube assembly into the air filter coupling hose and then into the coupling hose at the throttle body. Adjust the tube and filter for best fit and then secure with the provided hose clamps.



26. Connect the crank case vent hose to the fitting installed into the K&N intake tube as shown.

NOTE: On vehicles that are not equipped with a vent line from the driver's side valve cover to the intake tube, route the dry sump vent line to the fitting and then connect.



27. On vehicles that are equipped with a "Dry Sump" oiling system, assemble the provided crank case vent hose (08635) and quick disconnect fitting and clamp as shown.

NOTE: On vehicles that are not equipped with the vent line from the driver's side valve cover to the intake tube, this step is not necessary.



28. On vehicles that are equipped with a "Dry Sump" oiling system, install the crank case vent hose assembly onto the oil tank and then route it through the factory retaining clips and then connect the open end to the 90° fitting installed into the K&N intake tube.

NOTE: Some trimming of the hose may be necessary.

NOTE: On vehicles that are not equipped with the vent line from the driver's side valve cover to the intake tube, this step is not necessary.



29. On vehicles equipped with a "Wet Sump" oiling system, separate the nylon crank case vent hose from the 90° quick disconnect fitting.

NOTE: The nylon crank case vent hose can be sliced with a razor blade to ease separation, be careful so as not to cut too deep and destroy the fitting.



30. Cut the provided crank case vent hose to a length of 15" and install onto the factory 90° quick disconnect fitting.



31. Reinstall the 90° quick disconnect fitting onto the valve cover port and then connect the open end of the hose to the fitting installed into the K&N® intake tube.



32. Reconnect the Mass air sensor electrical connection.



33. Reinstall the air extraction duct and secure with the factory hardware.



34. Reconnect the vehicle's negative battery cable. Double check to make sure everything is tight and properly positioned before starting the vehicle.

35. The C.A.R.B. exemption sticker, (attached), must be visible under the hood so that an emissions inspector can see it when the vehicle is required to be tested for emissions. California requires testing every two years, other states may vary.

36. It will be necessary for all K&N® high flow intake systems to be checked periodically for realignment, clearance and tightening of all connections. Failure to follow the above instructions or proper maintenance may void warranty.

ROAD TESTING:

1. Start the engine with the transmission in neutral or park, and the parking brake engaged. Listen for air leaks or odd noises. For air leaks secure hoses and connections. For odd noises, find cause and repair before proceeding. This kit will function identically to the factory system except for being louder and much more responsive.

2. Test drive the vehicle. Listen for odd noises or rattles and fix as necessary.

3. If road test is fine, you can now enjoy the added power and performance from your kit.

4. K&N Engineering, Inc., requires cleaning the intake system's air filter element every 100,000 miles. When used in dusty or off-road environments, our filters will require cleaning more often. We recommend that you visually inspect your filter once every 25,000 miles to determine if the screen is still visible. When the screen is no longer visible some place on the filter element, it is time to clean it. To clean and re-oil, purchase our filter Recharger® service kit, part number 99-5050 or 99-5000 and follow the easy instructions.

INTAKE SYSTEMS FOR VEHICLES LISTED ARE 50 STATE LEGAL. SEE KNFILTERS.COM FOR CARB STATUS ON EACH PART FOR A SPECIFIC VEHICLE.