



Installation Instructions

Complete Replacement Soft Top

97 - 06 Wrangler

IMPORTANT NOTICE:

Carefully read instructions before attempting to install this product. Rampage Products is in no way responsible for any damage to the vehicle or personal injury that may occur during the installation or use of this product.

WARNING

This product is designed to enhance the appearance of the vehicle and only for protection against the elements. Do not rely on this product to contain occupants within the vehicle or to protect against injury during an accident.

WEAR SEAT BELTS AT ALL TIMES

INCLUDED COMPONENTS

QTY	DESCRIPTIONS	QTY	DESCRIPTIONS
1	Soft Top	1	(K) Windshield Channel
1	Soft Top Storage Bag	2	(L) Door Surround (Pass & Dvr)
1	Off Road Organizer	2	(M) Door Surround Front Brackets (P & D)
2	(A) 5/16"x 3/4" Torx Bolts	2	(N) Door Surround Rear Brackets (P & D)
4	(B) M6 x 25mm Torx screws	4	(O) Threaded Knobs
4	(C) 10-24 x 5/8"Phillips Machine Screws	2	(P) Side Bows
2	(D) #10 x 3/4" Sheet Metal Screws	2	(Q) Bow Assembly (Pass & Dvr)
2	(E) 5/16"Flat Washers	2	(R) Rear Bow Legs
4	(F) #10 Flat Washers	2	(S) Connector Tubes
4	(G) #10 Lock Nuts	2	(T) Bow Assembly Brackets (Pass & Dvr)
8	(H) #8 x 5/8"Sheet Metal Screws	8	(U) Clips
2	(I) #5/16"Nut Inserts	6	(V) Disconnect Pins
4	(J) #10 Star Washers	2	(W) Tailgate Brackets (Pass & Dvr)
		1	(X) Tailgate Bar w/ Tonneau

SOFT TOP INSTALLATION TIPS

To help ease the installation, be sure to install the top when temperatures are above 70° F. The material shrinks substantially at lower temperatures and may become difficult to install. The top may seem wrinkled when first installed, this is caused by the fabric becoming wrinkled in shipping. It will relax after a few days on the vehicle.



HARDWARE LIST

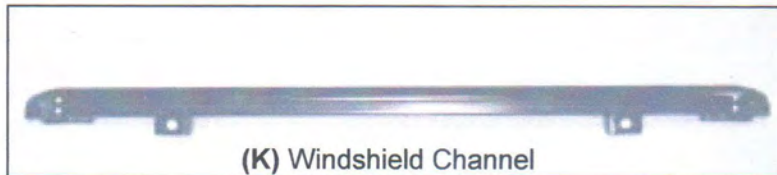
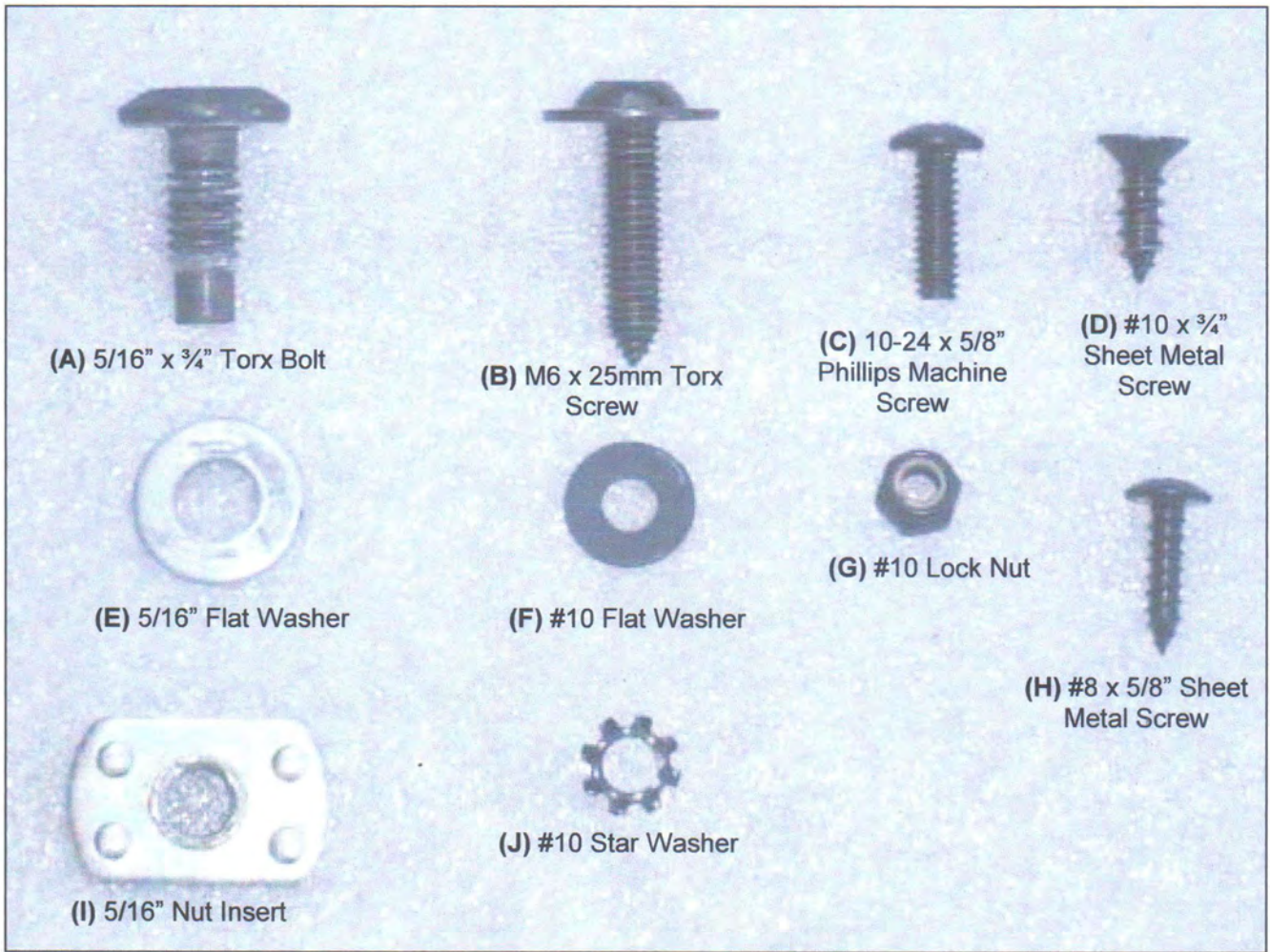

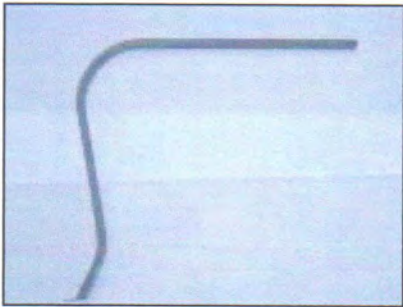

(L) Door Surround (Pass & Dvr)

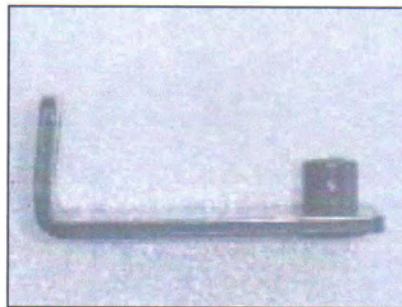

(M) Door Surround Front Bracket (Pass & Dvr)

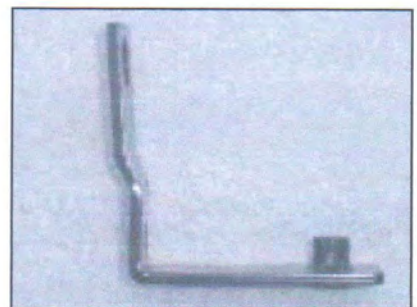

(N) Door Surround Rear Bracket (Pass & Dvr)

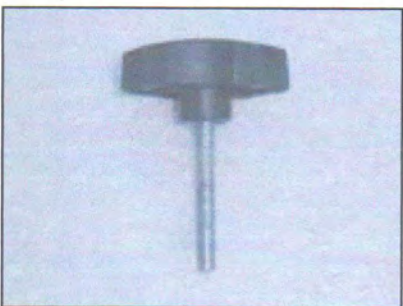

(O) Threaded Knobs

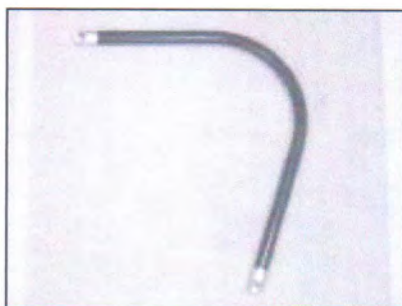

(P) Side Bow

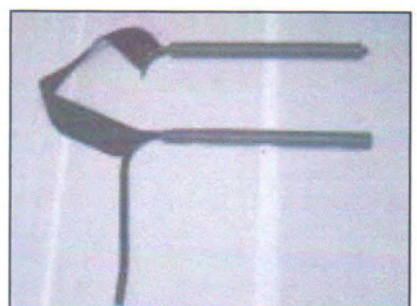

(Q) Bow Assembly (Pass & Dvr)

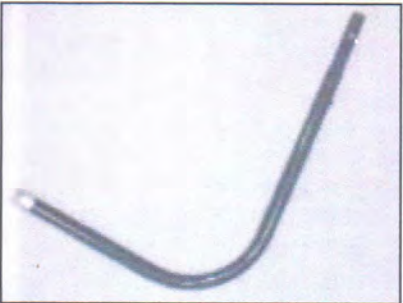

(R) Rear Bow Legs

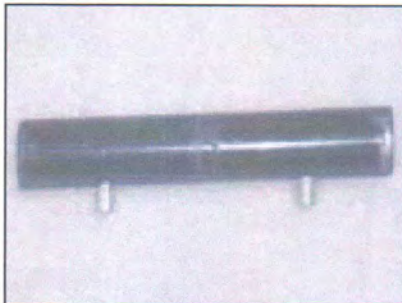

(S) Connector Tube



(T) Bow Assembly Brackets (Pass & Dvr)

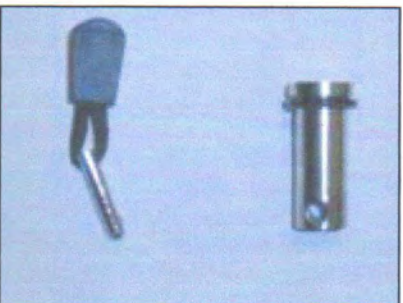

(U) Clips

(V) Disconnect Pins

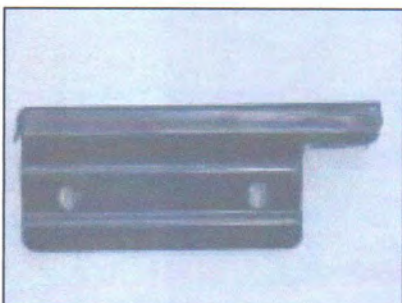

(W) Tailgate Brackets (Pass & Dvr)

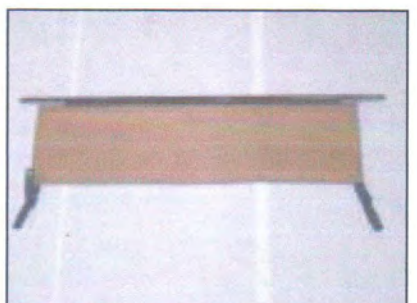

(X) Tailgate Bar w Tonneau

Windshield Channel Installation

1. Locate (K) Windshield Channel and remove brackets, save hardware for later use. Position Channel onto windshield and engage Bracket as shown in Figure 1. Secure Windshield Bracket assembly with hardware removed in this step.



Figure 1

WARNING: Ensure Windshield Channel is properly secured prior to installing the Soft Top. Damage to the vehicle or personal injury may occur if Windshield Channel is not securely mounted. Rampage Products is not responsible for personal injury or damage to the vehicle if Windshield Channel is not secured properly.

Door Surround Installation

2. Locate Driver Side Door Surround (L), Front (M), and Rear (N) Door Surround Bracket, (4) #8 x 5/8" Sheet Metal Screws (H). Attach Front and Rear Brackets to Door Surround with hardware listed in this step (Figure 2 & 3). **NOTE:** The Threaded Nipple on both brackets should face up and towards the inside of the vehicle.

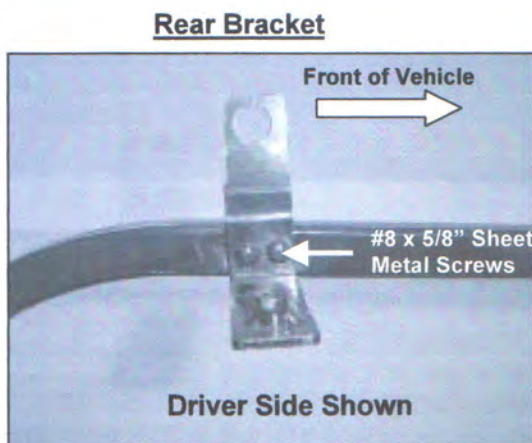

Figure 2

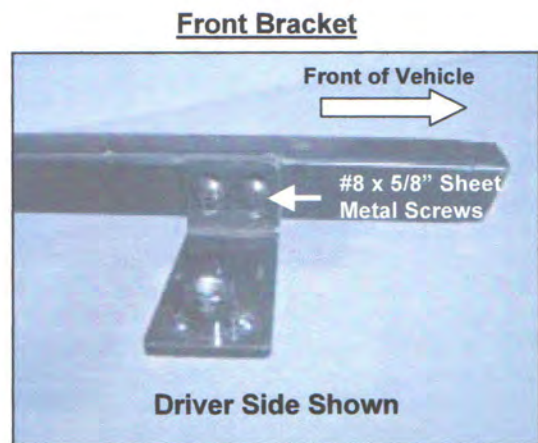

Figure 3

3. Orient Door Surround Assembly (**L**) on the vehicle with the Brackets towards the inside of the vehicle. Line up Threaded Nipples with holes on the bottom of the roll bar (Figure 4). Secure Door Surround Assembly to roll bar by inserting Knobs (**O**) from the top of the roll bar until it reaches the Threaded Nipples. Do not tighten at this time.
4. Locate (1) 5/16" x 3/4" Torx Bolt (**A**), (1) 5/16" Flat Washer (**E**), and (1) 5/16" Nut Insert (**I**). Secure the bottom of the Door Surround to vehicle by using the hardware listed in this step (Figure 5). Tighten hardware listed on step 3 & 4 at this time.
5. Repeat steps 2-4 for opposite side.

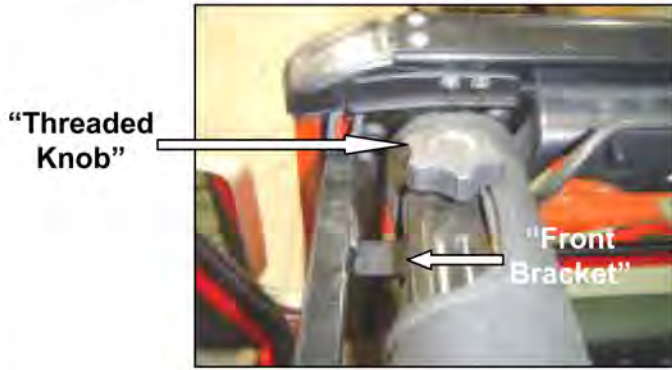

Figure 4



Figure 5

Bow Assembly Installation

6. Locate driver side Bow Assembly Bracket (**T**) and (2) M6 x 25mm Torx Screws (**B**). Unzip side center roll bar cover and mount Bracket by using the hardware listed in this step (Figure 6). **NOTE:** Slits on the roll bar cover should match Bracket. Close zipper once the bracket is attached to roll bar.
7. Locate (1) Side Bow (**P**) and (2) Billet Disconnect Pin w/ Clips (**U & V**). Attach top section of the Side Bow to Rear Door Surround Bracket and secure it with Billet Disconnect Pin (Figure 7). **NOTE:** Hole on the Side Bow should be on top. *To ease the installation of the Side Bow, it is very important to install Side Bow to the Door Surround Rear Bracket first.*
8. Once the top of the Side Bow (**P**) is secured, attach opposite side of the Side Bow to the upper hole on Bow Assembly Bracket (**T**) (Figure 8). Secure it with Billet Disconnect Pin w/ Clip (**U & V**).



Figure 6

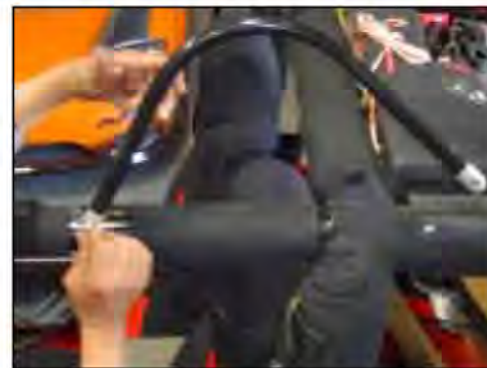

Figure 7



Figure 8

9. Locate (2) Connection Tubes (**S**), Left and Right Bow Assembly (**Q**) and lay them on a flat clean surface and identify the Front and the Rear Bow. **NOTE:** The Front Bow has one pin on each side.
10. Assemble the two halves of the Bow Assembly using the included Connection Tubes with push buttons (Figure 9) **NOTE:** It may be helpful to use a screw flat driver to push down the buttons while sliding Bow halves together. Also, it may helpful for two persons to slide both sides of the Bow Assembly forward simultaneously.

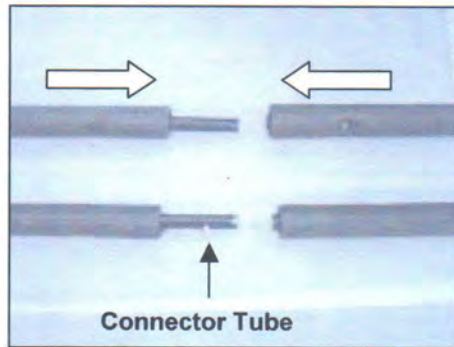

Figure 9

11. Locate Rear Bow Leg (**R**) and remove outer sheet metal screw. Slide Bow Leg into Rear Bow Assembly (**Q**). Line up holes on the Leg and the Bow Assembly and secure them together by re-installing the sheet metal screw (Figure 10). Repeat this step for opposite side.
12. Once the Bow Assembly is fully assembled, place it on the back of the vehicle. Line up the holes on the Bow Legs to the lower hole on the Bow Assembly Bracket (Figure 11). Secure them by inserting Billet Disconnect Pin.



Figure 10



Figure 11



Figure 12

13. Take Front Bow towards the front of the vehicle. There is a Pin on each side on the Front Bow. Insert these Pins through the holes on the Side Bow and secure them with Billet Disconnect Pins provided (Figure 13).

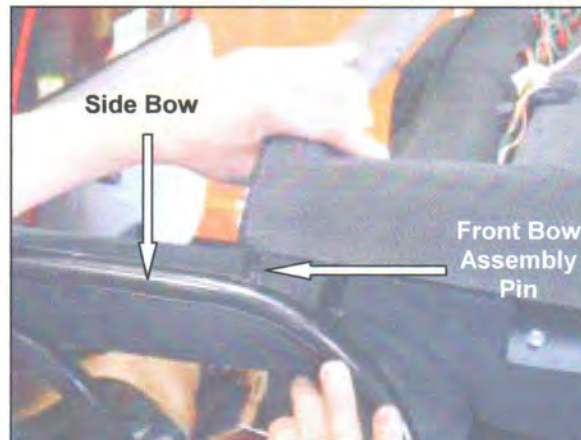

Figure 13

Tailgate Brackets Installation

14. Locate Passenger Tailgate Bracket (**W**), (2) - #10-24 x 1/2" Phillips Machine Screws (**C**), (2) - #10 star lock washers (**J**), (2) - #10 Flat Washers (**F**) and (2) - #10-24 Nylock Nuts (**G**). In some cases the holes on the Tailgate Bracket will line up with existing holes. In this case, use the existing holes as pilots to drill 3/16" holes on the vehicle. **NOTE:** Carefully check under the drilling area to be sure you do not drill into any concealed wiring.

NOTE: If you are replacing a hardtop, use the Tailgate Bracket as a template to drill 3/16" holes. Position Tailgate Bracket and secure it by using the hardware listed in this step (Figure 14 & 15). Repeat this step for opposite side.

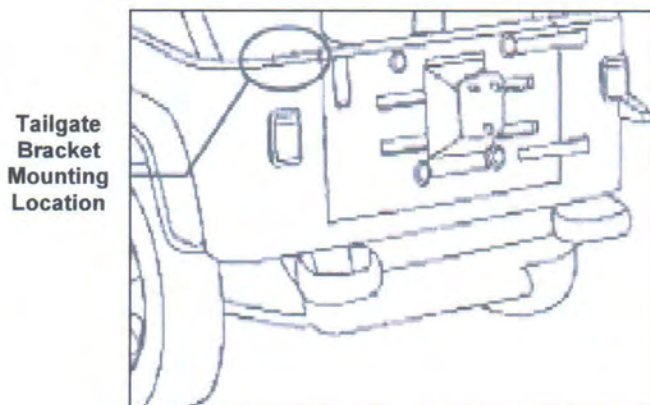

Figure 14



Figure 15

Fabric Replacement Top Installation Instructions

1. Locate Soft Top, remove rear and quarter windows from top. Once you have removed the windows orient Soft Top on the vehicle.
2. Snap the Soft Top to the center and rear Bow Assembly (Figure 16 & 17).
3. Insert the front of the Soft Top into Windshield Channel (Figure 18).

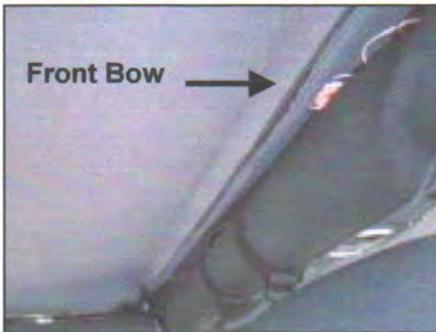

Figure 16

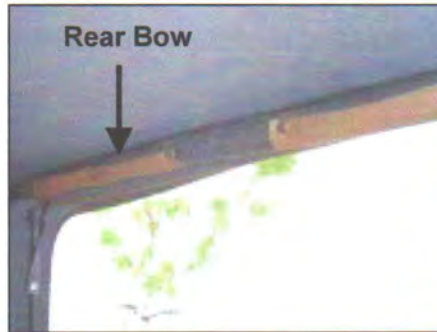

Figure 17

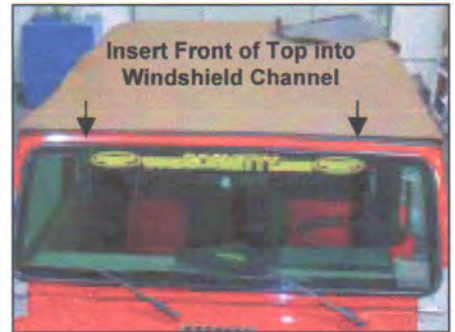

Figure 18

4. Insert rear corners of the Soft Top into rear corner belt rail (Figure 19).
5. Start horizontal and vertical zippers on the Quarter Window about 4-6 inches (Figure 20).
6. Insert the Plastic Strip on the bottom of the Quarter Window into the Side Belt Rail (Figure 20). **NOTE:** Start at one end of the strip and work along it to the other end. Close the horizontal and vertical zippers on the Quarter Window.
7. Wrap the front of the Quarter Window around Door surround and secure it by hooking velcro together.
8. Wrap overhead flap around Upper Door Surround and secure it by hooking velcro together (Figure 21). Repeat steps 5-8 for opposite side.



"Rear Corner"

Figure 19

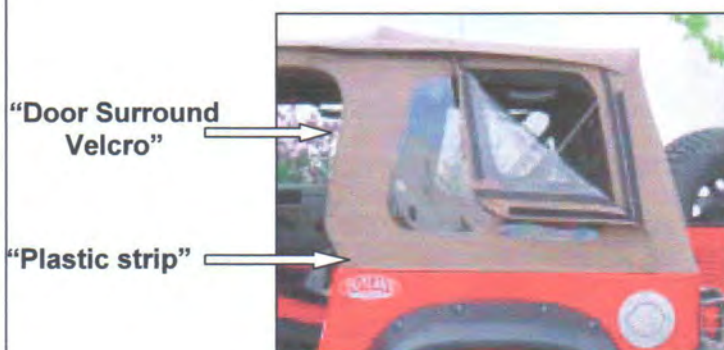

Figure 20



Figure 21

Tailgate / Tonneau Installation

9. Open tailgate and attach rear window to top by closing the upper zipper only.
10. Locate Tailgate Bar and Rear Tonneau Cover. Slide extrusion on the Tonneau Cover into Tailgate Bar Rail as shown in Figure 22.



Figure 22



11. Once the Rear Seat Tonneau Cover is attached to Tailgate Bar, slide it into Rear Window extrusion located on the bottom of the rear window (Figure 23)
12. Close the Rear Window zippers and attach the bottom extrusion of the Rear Window to channel on the Tailgate Bracket. **NOTE:** Tailgate Brackets are adjustable and need to be tightened periodically.
13. Push the Tailgate Bar into the top of the Tailgate Brackets (Figure 24).



Figure 23



Figure 24

14. Locate Weather Strip and attach it to tailgate by inserting tailgate into channel on the Weather Strip (Figure 25). **NOTE:** Make sure the Weather Strip is fully engage before closing the tailgate.



Figure 25

15. Fold seat forward and position the Rear Seat Tonneau Cover. Use the hole on the strap as a guide to mark the hole on the fender (Figure 26)
16. Place strap aside and drill a 1/8" hole on the just marked locations. **NOTE:** Carefully check under drilling area to be sure you do not drill into any concealed wiring.
17. Re-position Rear Seat Tonneau Cover and attach both sides to the just drilled holes by using the included (2) - #8 x 1" Sheet Metal Screws (Figure 27)

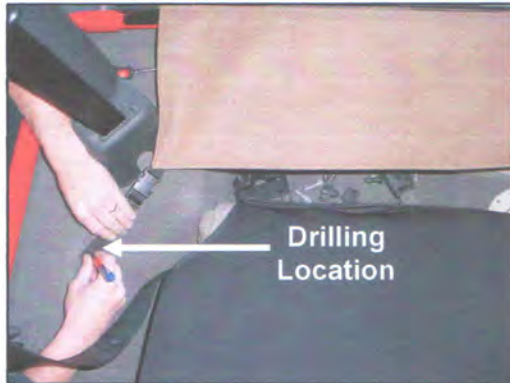

Figure 26



Figure 27

REMOVING SOFT TOP TIPS

- Remove all Windows from Soft Top and store them in the Storage Bag Included
- Remove Soft Top and Store it in the Storage Bag included
- To store the Bow Assembly behind rear seat, simply remove both Clips from Front Bow Assembly and carefully orient Bows behind rear seat. **NOTE:** Bottom sides of the Rear Bow may need to be pushed in slightly towards the inside of the vehicle as you orient the bows behind the seat.

Upper Door Installation/Adjusting Instructions for Non Iron Side Door Soft Tops **Rampage Products #683xx & 685xx**

- 18 .Install the upper half door onto the vehicle door.
19. Now tighten the bottom velcro to achieve the desired fabric to frame to retaining strip tension (Figure 28).

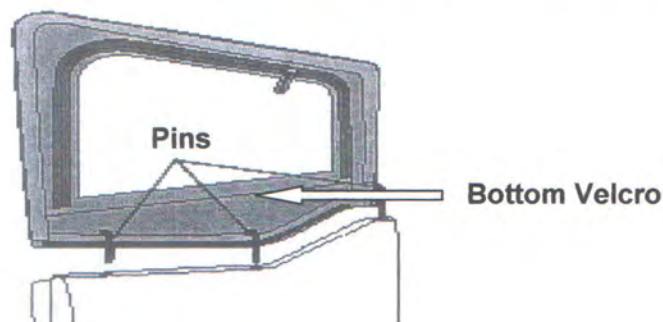

Figure 28

LIMITED 2 YEAR WARRANTY

Applies to Replacement Soft Top by Rampage Products

Rampage Products (the company) warrants to the original purchaser of this product that should the product or any part thereof, under normal use and conditions, be proven defective in material or workmanship within 2 years from the date of original purchase, such defect(s) will be repaired or replaced (at the Company's option) without charge for parts or repair labor. Please note that installation labor to remove or install this product is not covered under this limited warranty.

To obtain repair or replacement within the terms of this Warranty, the product is to be delivered with proof of warranty coverage (e.g. dated bill of sale), specification of defect(s), freight pre-paid to the place of purchase or, you must contact Rampage Products at the number below for warranty service or to obtain a Return Goods Authorization Number. **NOTE:** Items returned to Rampage Products without an Authorized Returns Good Authorization number will be refused and returned back to sender at the senders expense.

This warranty does not apply to any product or part thereof which, in the opinion of the Company, has suffered or been damaged through alteration, improper installation, mishandling, misuse, neglect, accident or by acts of nature. THE EXTENT OF THE COMPANY'S LIABILITY UNDER THIS WARRANTY IS LIMITED TO THE REPAIR OR REPLACEMENT PROVIDED ABOVE AND, IN NO EVENT, SHALL THE COMPANY'S LIABILITY EXCEED THE PURCHASE PRICE PAID BY PURCHASER FOR THE PRODUCT.

This warranty is in lieu of all express warranties or liabilities. ANY IMPLIED WARRANTIES, INCLUDING ANY IMPLIED WARRANTY OF MERCHANTABILITY, SHALL BE LIMITED TO THE DURATION OF THIS WRITTEN WARRANTY. ANY ACTION FOR BREACH OF ANY WARRANTY HEREUNDER INCLUDING ANY IMPLIED WARRANTY OF MERCHANTABILITY MUST BE BROUGHT WITHIN A PERIOD OF 90 DAYS FROM DATE OF ORIGINAL PURCHASE. IN NO CASE SHALL THE COMPANY BE LIABLE FOR ANY CONSEQUENTIAL OR INCIDENTAL DAMAGES FOR BREACH OF THIS OR ANY OTHER WARRANTY, EXPRESS OR IMPLIED, WHATSOEVER. No person or representative is authorized to assume for the Company any liability other than expressed herein in connection with the sale of this product.

Some states do not allow limitations on how long an implied warranty lasts or the exclusion or limitation of incidental or consequential damage, therefore above limitations may not apply to you. This Warranty gives the purchaser specific legal rights. The purchaser may have additional rights, which vary from state to state.

Rampage Products
9225 Stellar Court Unit C, CORONA, CA 92883-4919, U.S.A.
Phone: (951) 277-4949 Fax: (951) 277-2295
e-mail: info@rampageproducts.net
Web: www.rampageproducts.net
Made in China